

# TASCAM

## TEAC Professional Division

# 246

### PORTASTUDIO



**OWNER'S MANUAL**

5700070501

Recording is an art as well as a science. Most of you will be more interested in the art than in the science. A recording will probably be judged successful primarily on its qualities as a work of art. We cannot guarantee that your recording will be well received critically; in the same way that a paint brush maker cannot guarantee the quality of the paintings made with its products.

Your skill as a technician and your abilities as an artist will be significant factors in the results you achieve. Your Portastudio does provide you with the tools necessary to make a successful recording whether it is judged using artistic or scientific criteria.

Understanding what is going on inside your equipment will help improve your sound. Think of this manual as a reference book. You won't need to memorize it to get started, but try to find the time to read it thoroughly at least once. That way, you will be familiar with its contents, and if you need answers, you'll know where to find them.

## TABLE OF CONTENTS



<b>Introduction</b> .....	3
The Mixer .....	4
The Recorder .....	6
Precautions and Recommendations .....	7
<b>Recording the First Track</b> .....	8
<b>Recording the Second Track</b> (Overdubbing) .....	10
<b>Ping-pong, Collapsing, or Bouncing</b> Tracks .....	11
<b>Remix or Mixdown</b> .....	13
<b>Punch-in and Insert Editing</b> .....	14
<b>Work Methods: Getting a Satisfactory</b> Recording .....	16
Applications .....	24
Features and Controls .....	26
Accessories .....	35
Voltage Conversion .....	39
Note for U.K. Customers .....	39
Pictogram .....	40
Block Diagram .....	41
Level Diagrams .....	43
Specifications .....	44

“ © Copyright 1985, TEAC Corporation”  
 All rights reserved under international and Pan American copyright conventions.  
 This book may not be reproduced in whole or in part, by mimeograph or any other means, without permission.

“The following marking is located on the bottom of the unit.”

**WARNING:**  
**TO PREVENT FIRE OR SHOCK HAZARD, DO NOT EXPOSE THIS APPLIANCE TO RAIN OR MOISTURE.**

This apparatus has a serial number located on the rear panel. Please record the model number and serial number and retain them for your records.  
 Model number \_\_\_\_\_  
 Serial number \_\_\_\_\_

<p><b>CAUTION</b>  <small>RISK OF ELECTRIC SHOCK          DO NOT OPEN</small></p>	<p>CAUTION: TO REDUCE THE RISK OF ELECTRIC SHOCK, DO NOT REMOVE COVER (OR BACK). NO USER-SERVICEABLE PARTS INSIDE. REFER SERVICING TO QUALIFIED SERVICE PERSONNEL.</p>
	<p>The lightning flash with arrowhead symbol within an equilateral triangle, is intended to alert the user to the presence of uninsulated “dangerous voltage” within the product’s enclosure, that may be of sufficient magnitude to constitute a risk of electric shock to persons.</p>
	<p>The exclamation point within an equilateral triangle is intended to alert the user of the presence of important operating and maintenance (servicing) instructions in the literature accompanying the appliance.</p>

## Introduction

---

The 246 Portastudio is a completely self contained four track production system designed to meet the needs of the musician/composer, multi-image and video producer. TASCAM's many years of experience in the manufacture of professional production equipment, our willingness to listen to and document the needs of the user, and our innovative engineering capability have combined to make the 246 Portastudio the most complete product of its type.

Light weight and conveniently sized, the Portastudio is a single package that contains a full function mixer and a four track two-speed cassette recorder with transport remote capability, programmable memory capabilities, and dbx noise reduction. This may seem like a lot of features to be present in one box, and it is. Although the general rule of thumb suggests that the more functions you put in a small amount of space, the more complicated the product is to use, this not the case with the Portastudio.

If you have ever been in a commercial recording studio, you probably didn't have too much trouble picking out the mixing console and the tape recorder. What may have been more difficult to figure out is the way they (the mixer and the tape machines) were hooked together. If you asked the question, you may have been shown one or more patch bays complete with a spider web tangle of wires. The Portastudio by its nature as a single piece of equipment, simplifies the patching process by making many of the same connections internally. A single switch or control is all that's needed to perform a whole series of patching functions. TASCAM experience in the professional multi-track recording industry has been used to make the Portastudio elegant, flexible, and simple to use despite its sophisticated features.

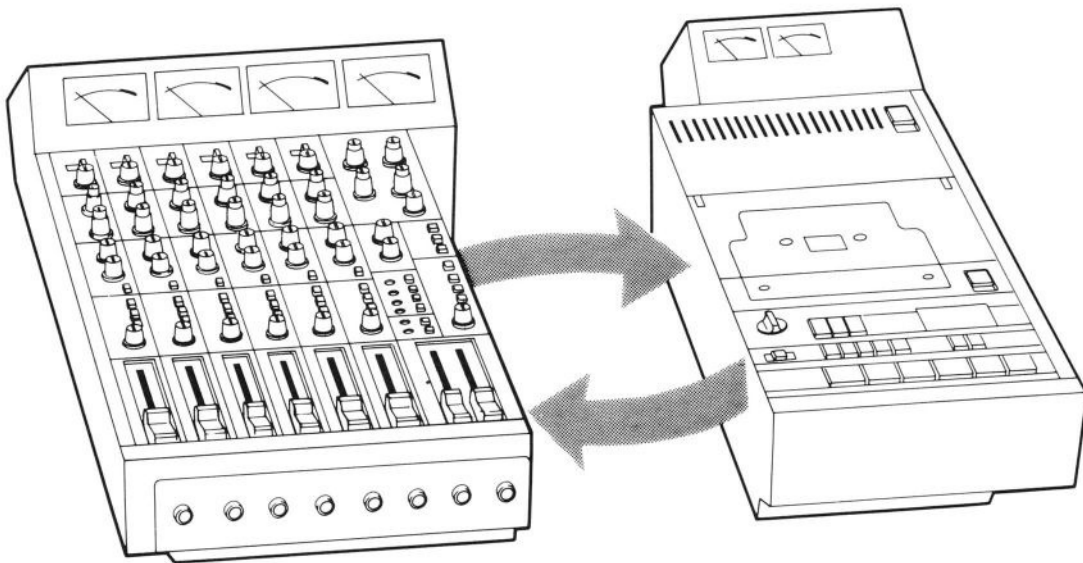

## THE MIXER

The mixer is the traffic control center of the recording studio. Everything that goes to or comes from the recorder, the talent, the signal processors, or anywhere else passes through the mixer. On many occasions during the recording process, the signals are flying every which way all at once. The talent is listening to previously recorded tracks while recording another track that is being sent to a signal processor, etc. With this much activity, it's easy to see that a mixer's greatest assets are flexibility and efficiency.

By definition, a mixer receives audio signals from somewhere, combines them in varying proportions, and sends them somewhere else. So audio mixers do two things, they control

"How Much?" and "Where?" (to or from). The signals could come from the talent (your instrument or voice), the recorder (a previously recorded track), or somewhere else (a signal processor, another recorder, etc.). Between its inputs and outputs, the mixer in the Portastudio uses a series of submixers to organize and route the signals to various locations. There are four of these submixers in the Portastudio: the Main Mix, Monitor Mix, and two Effect Mixes. These submixes are used to accomplish the recording procedures of overdubbing, ping-ponging, and remix. While you're reading the following explanations of the submixes, keep the "Where?" and "How Much?" questions in mind.

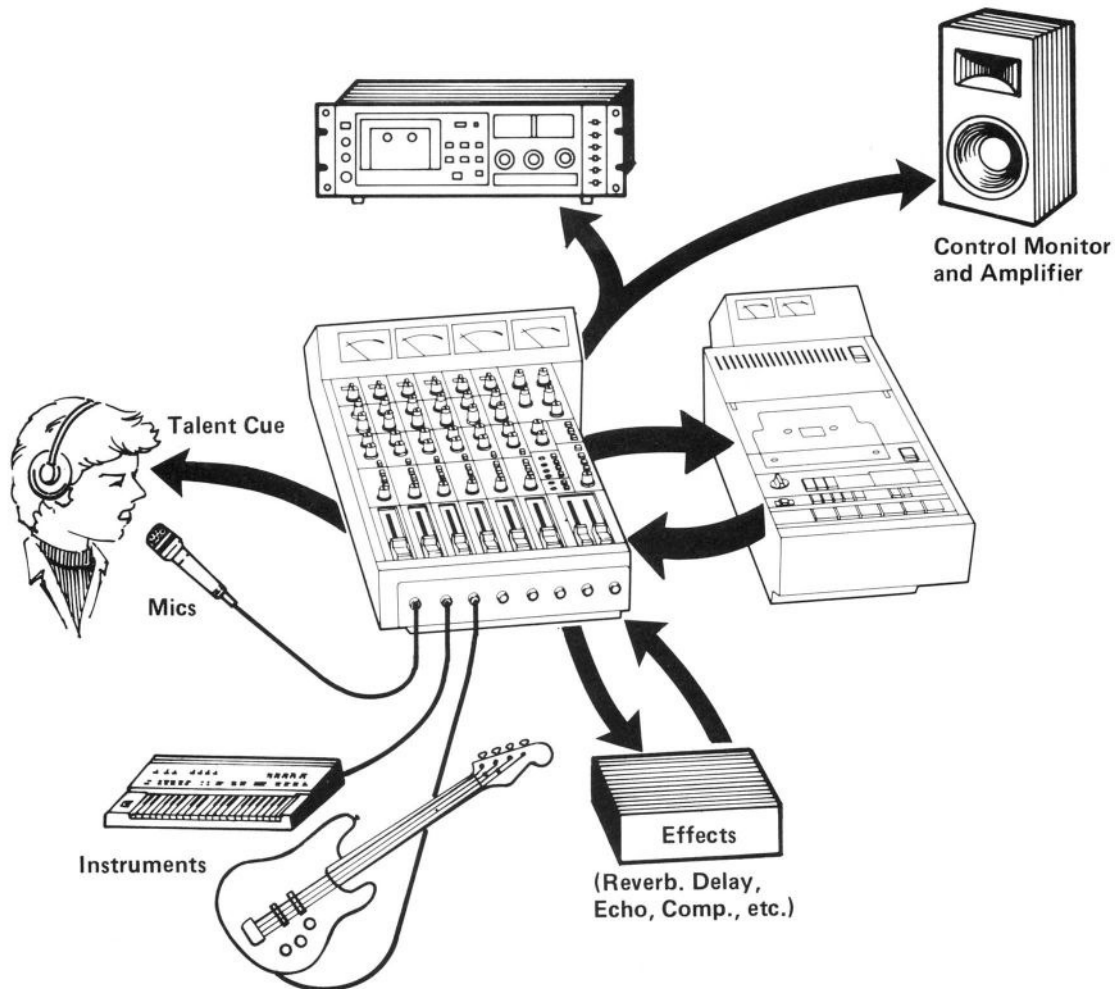

The Main, or Program Mix is the primary mixing system. It accepts channels inputs from microphones, instruments, any line level signal, or the 246 recorder sending the resulting mix to the recorder, the other submix systems, or the stereo and program outputs. The MAIN MIX is also used to perform the Remix process. Remix converts your multitrack recording to a stereo or mono master recording

— the finished product. Your MAIN MIX system also allows your Portastudio's mixer to be used as an independent stereo mixer.

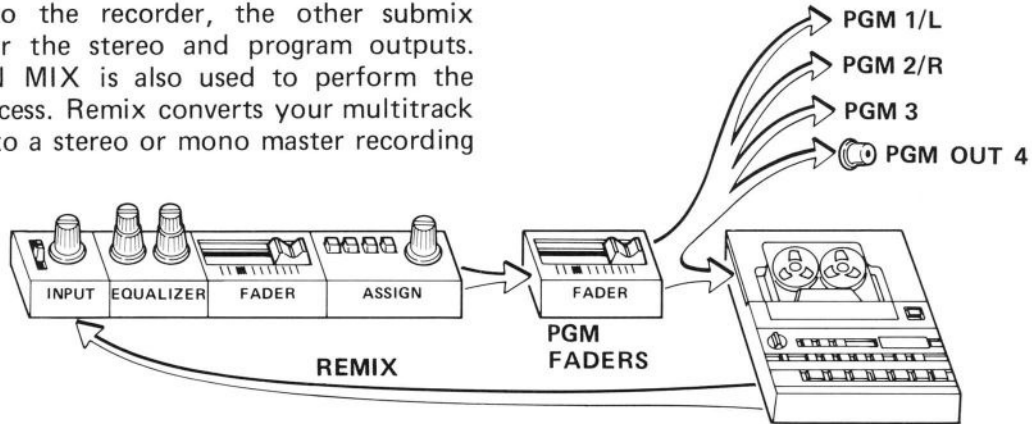

The MONITOR MIX takes its signal from the recorder's playback or PGM Buss. These signals are automatically patched through individual level and pan controls. Monitor mixes are used so that the talent can hear previously recorded and new material while recording or rehearsing the overdubbing process.

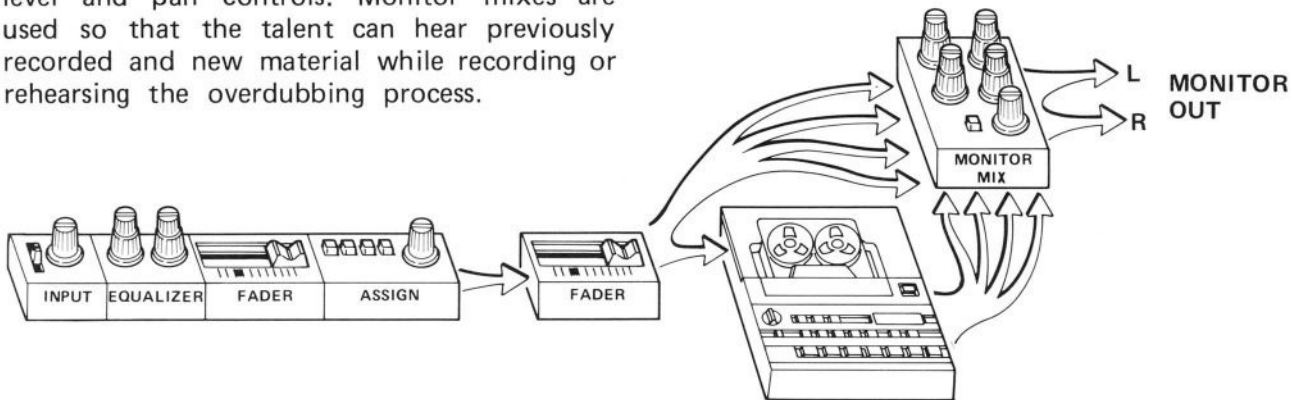

The EFFECT system's signals come from the MAIN MIX system. Let's assume you have a digital delay, reverb, or some other signal processor that you want to use on some of the material you're recording. If you only want the effect on one track, you could just plug your

instrument into the effect and plug the output of the effect into the Portastudio, or use the INSERTion jack in each channel. But suppose you want to use your reverb on your voice and

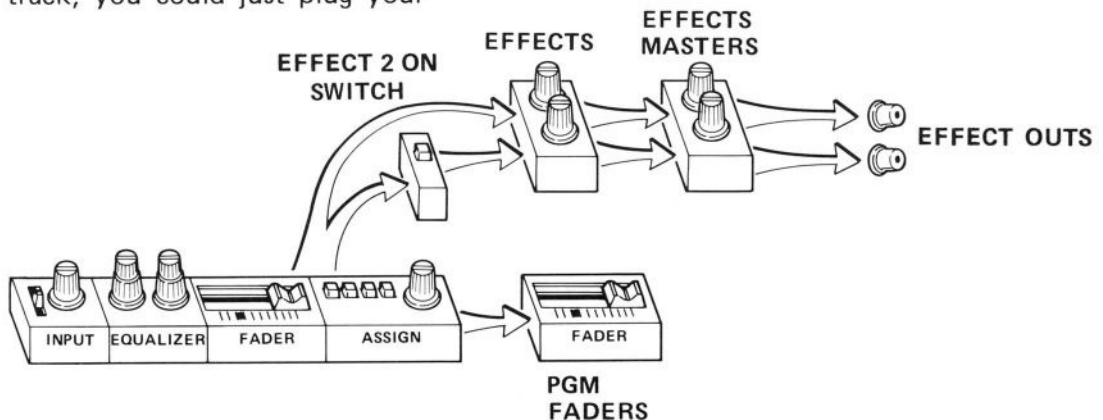

---

your instrument, which you're recording simultaneously. Your Portastudio's EFFECT mixers are able to send signals to a pair of EFFECT OUTPUTS on the back of the unit. These outputs are then plugged into your reverb unit and the reverb's outputs are connected to the LINE B INPUTS of channels 5 and/or 6, so we see that the EFFECT system lets you decide "How Much?" reverb will be used on which channel ("Where?").

## THE RECORDER

A recorder's job is pretty easy to understand. It records. Of course, it also plays. Your Portastudio's recorder uses audio cassettes to record up to four tracks of sound. Your recorder differs from the one in your stereo setup in a couple of important ways: It records in one direction, and it can record at two different speeds.

The two speed operation of the Portastudio makes it compatible with standard pre-recorded cassettes and those recorded on the TASCAM Porta One that run at 1-7/8 ips — inches per second (4.8 cm/sec.) and also with cassettes recorded on the 234 Syncaset and 244 Portastudio that run at 3-3/4 ips (9.5 cm/sec.). This faster tape speed is important, not only for compatibility with other Portastudios, but because it improves sound quality.

The Portastudio's dbx system virtually eliminates unwanted tape noise. The dbx system can be turned off if you are working with, or auditioning, tapes using Dolby or some other noise reduction system. SMPTE time code and FSK synchronizing tracks can also be recorded on track 4, which has a separate dbx off switch. These time codes and some older model drum machines can create tracking errors in the dbx system.

Your Portastudio can be REMOTE(ly) controlled. If you are sitting in front of your instrument and not the Portastudio, the tape transport controls, Play, STOP, Fast Forward, Rewind, and RECOrd can be located up to sixteen feet (five meters) away from the recorder using the optional RC-71. Punch-in and out can be engaged using the optional RC-30P footpedal, which gives you an extra hand in the recording process.

The PITCH CONTROL allows you to adjust the speed, and thereby the pitch, of the Portastudio during playback or record by as much as 12 % plus or minus. This has a variety of uses from coping with a singer who thinks the world is a semi-tone sharp, to cutting a few seconds from your tape. As an example, suppose your thirty second commercial runs 31.5 seconds. The pitch adjustment can be used to make the material fit the time constraints.

The Portastudio's MEMORY is not only a convenience for the user, it handles your tape very gently. The MEMORY and ZERO RETURN functions work with your Portastudio's tape transport to minimize the strain placed on your tape by the fast forward rewinds and searches. The MEMORY functions can be used with the ZERO RETURN to automate your search and tape handling operations. You can also use the REWInd and PLAY functions to create a playback loop that will repeat until you turn it off.

## Precautions and Recommendations

### Track Format and Compatibility.

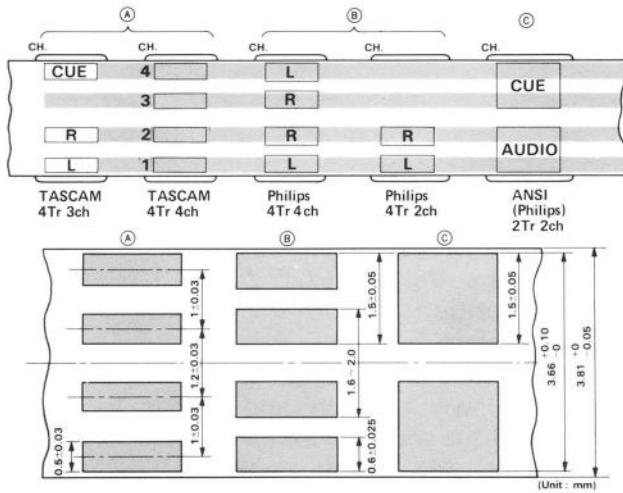

*The 246 Portastudio Records and Plays in One Direction Only.*

Never turn a tape over. If you do you will erase your previous work.

*Protect Your Finished Master Tape by Removing Both Safety Tabs.*

If you only break out one tab, you will still run the risk of erasing your work if you mistakenly put the tape in the machine up side down.

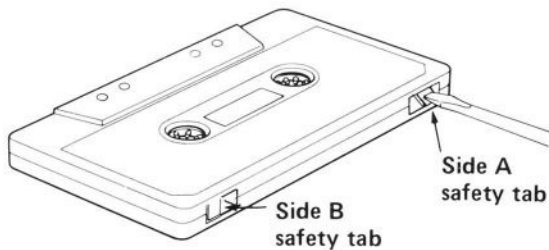

### Compatibility With Other TASCAM Models.

Tapes using Dolby Noise reduction from TASCAM models 144, 122, 122B, 133, 133B, and 225 will not reproduce properly on the 246 Portastudio.

234 and 244 tapes are compatible using the 246's High Speed setting and Porta One tapes are compatible using the Low Speed setting.

If you must use the Portastudio to audition Dolby encoded tapes, turn the dbx off and adjust the high frequency EQ control (1 kHz to 8 kHz) until you get the proper sound. If you

are using a normal bias tape (120  $\mu$ s) you will also need to adjust the high frequency EQ to get the proper sound upon playback.

### Do Not Use C-120 Cassettes.

C-120 cassettes use extremely thin tape which can lead to winding and crimping problems as well as wrinkling and other tape problems that can destroy your work and cause maintenance problems for your Portastudio.

### Always Use the Shortest Possible Tape.

The shorter the tape, the thicker it usually is. A thick tape is more durable. Since the recording and remix processes cause the tape to be played, rewound, and manipulated many times, the more durable tape will have a better chance of coming through these operations intact. When considering this advice, remember that the Portastudio's High Speed setting and full track format reduce the playing time of cassettes. Since you can only use one side, the time of a tape is reduced by half, a C-90 will only play 45 minutes. And since it will be playing at twice the normal speed, the C-90 tape will give you 22-1/2 minutes of program time.

*The 246 Portastudio is Adjusted for High bias, 70  $\mu$ s EQ, Type II Tape.*

Always use high bias 70  $\mu$ s tapes such as TDK SA X; TDK HXS; Maxell UD IIS, or equivalent formula tapes.

# Recording the First Track

## SET UP

1. Load a new cassette into the tape compartment of the Portastudio. You should remove the B side record tab on the cassette before putting the tape into the transport. Switch SPEED selector to the HIGH position.
2. Plug a microphone or your instrument into the MIC/LINE INPUT for channel 1 on the front panel. The power should be off while making any connections.
3. Plug your headphones into one of the jacks on the front panel. You needn't put them on yet. Never use mono headphones with your Portastudio!
4. Switch on the dbx. It should be on when your Portastudio comes out of the box, but just make sure that both switches are in the up position.
5. Turn on the power for the Portastudio.
6. Run the tape past the leader by pressing the Play button and letting the recorder run for approximately fifteen seconds. Press STOP. Press the RESET switch. Press the ZERO RE-

- TURN STOP switch. The TRT switch should be in the off position.
7. Set the channel 1 INPUT selector switch to the MIC/LINE position.
8. Set channels 2–6 INPUT selectors to the OFF position.
9. Turn the TRIM control fully counterclockwise.
10. Adjust the EQ controls to the 12 o'clock position.
11. Adjust the fader control for channel 1 to the shaded area between 7 and 8.
12. Leave the EFFECT 2 on/off selector in the off position and turn the EFFECT 1 control fully counterclockwise.
13. Press the ASSIGN switch marked L/1 to the down position and rotate the PAN control all the way counterclockwise (ODD).
14. Press the switch marked MONITOR in the PHONES section.
15. Adjust the L/ODD PGM MASTER fader to the shaded area between 7 and 8.
16. Make sure the CUE/PGM switch is in the

## Set up

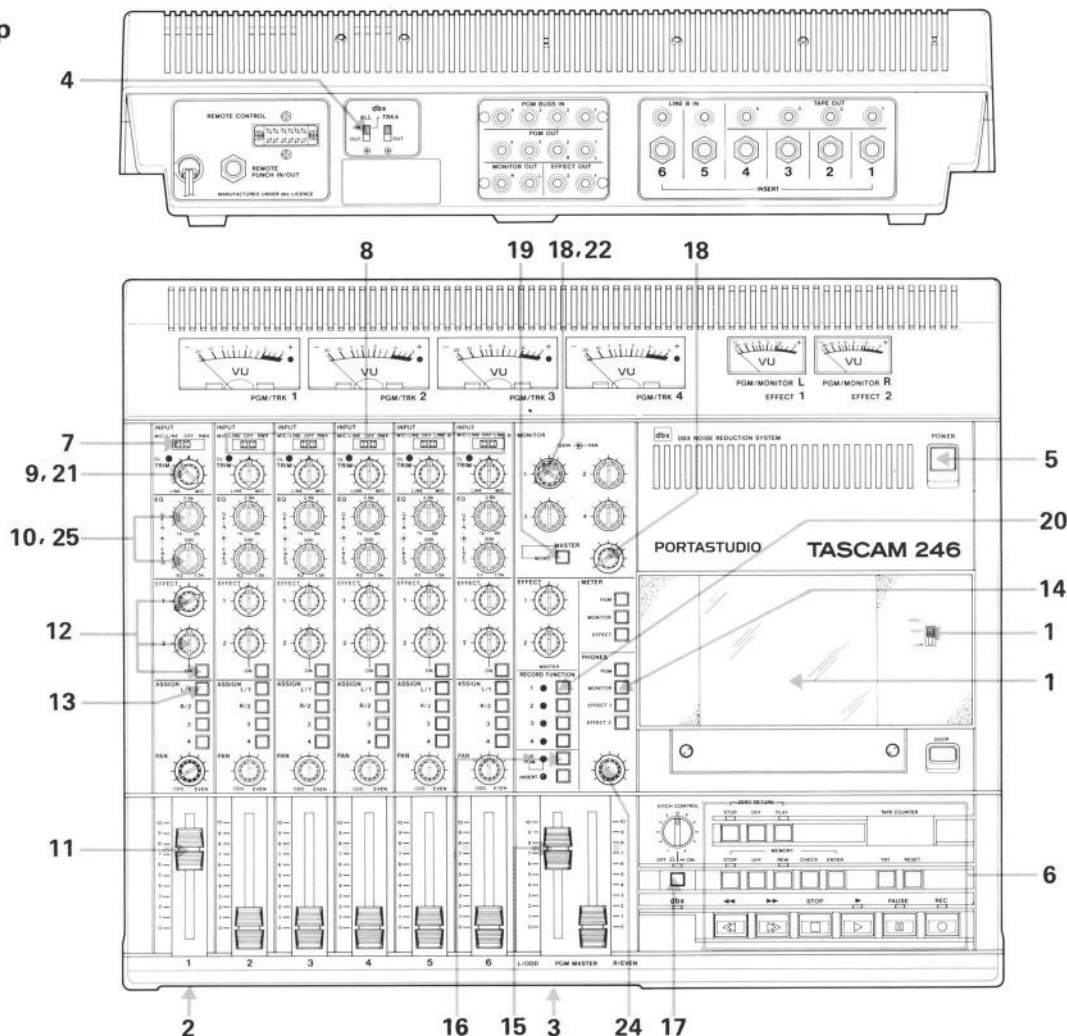



CUE (up) position with its LED off. This will allow you to visually monitor the input level using the PGM/TRK 1 meter.

17. The PITCH CONTROL switch should be in the off (up) position with its LED off.

18. Turn the MONITOR GAIN control number 1 fully counterclockwise, and make sure that the MONITOR MASTER control is set approximately to the two o'clock position. Rotate the PAN control number 1 to the left, fully counterclockwise.

19. You may find it easier to work in the mono mode, if so, press the MONO switch in the MONITOR section.

20. Press the number 1 switch in the RECORD FUNCTION section. The LED (Light Emitting Diode) near the number 1 switch should be blinking.

21. Play your instrument or speak into your microphone checking the level on your meter for channel 1 as you do so. The meter should read somewhere between -10 and 0. The OL indicator light should not come on, although it may flash briefly. Adjust your level using the TRIM control or at your instrument.

22. Rotate the MONITOR GAIN number 1 all the way to the right, clockwise.

23. Put your headphones on.

24. Adjust the PHONES level control to a comfortable level.

25. Make any adjustments you feel are necessary to the EQ controls of channel 1.

## RECORDING

1. Press the REC and Play buttons together to start recording. The REC LED and the RECORD FUNCTION LED number 1 should stay on continuously.

2. Play your instrument or count using just the odd numbers slowly to twenty. Pause for a full count between each number.

3. When finished, press the Rewind button. Since the ZERO RETURN STOP is on, the tape will automatically stop at the display reading of 0000. ZERO RETURN does not work in the TRT counter mode.

4. Press the number 1 switch in the RECORD FUNCTION section turning off the record ready mode and the LED.

5. Press the ASSIGN L/1 switch in channel 1 of the mixer. It will come back to the up position.

6. Press the Play button and listen to your track. Readjust PHONES level if necessary.

You've completed your first track. If you are not satisfied with your results, repeat the procedure. If your results are satisfactory, it's time to move on to the Overdubbing process.

## Recording

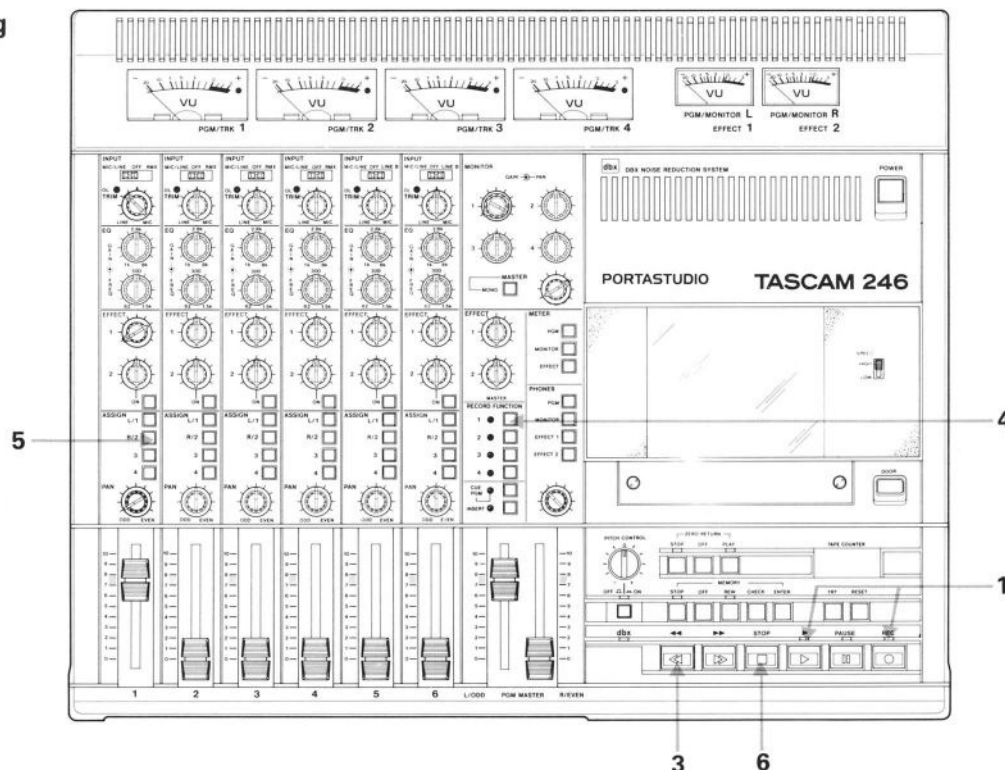

# Recording the Second Track (Overdubbing)

You will use the same setup as the one used for recording track one with the following changes:

1. Connect the new source, instrument or microphone to the channel 1 input. You can continue to use channel 1 because the channel's ASSIGN makes it possible to route any channel to any track of the recorder.
2. Press the ASSIGN switch R/2 and adjust the channel 1 PAN control all the way to the right, clockwise (EVEN).
3. Press the number 2 RECORD FUNCTION switch and the LEDs should be blinking.
4. Adjust PGM MASTER R/EVEN fader to the shaded area between 7 and 8.
5. Turn MONITOR GAIN control 2 all the way to the right, clockwise.
6. Press the Play button and listen to the first track and your new material through the MONITOR section. Turn up GAIN control 2 and play your instrument or, if you counted on the first track, count again on the second, using the even numbers and placing the new numbers during the pauses made during the

recording of the first track. Adjust the volume of your new material to match that recorded on your first pass.

7. Rewind the tape.
8. Press the RECord and Play buttons. The REC and RECORD FUNCTION LEDs should stay on continuously. The second track is now being recorded. You should be able to hear the first track, so play, or count.
9. Press STOP and the Rewind button.
10. Press the ASSIGN switch R/2 in channel 1, turning it off, to the up position.
11. Press the number 2 RECORD FUNCTION switch turning it off (up position).
12. You can now listen to both tracks through the MONITOR system. Press the Play button and adjust the GAIN controls.

Tracks 3 and 4 can be recorded using almost the identical procedures as tracks 1 and 2. The differences, of course, are that the numbers 3 and 4 switches are used in the ASSIGN and RECORD FUNCTION sections, and the PAN controls are rotated to the ODD position for track 3 and the EVEN position for track 4.

## Overdubbing

5, 6, 10

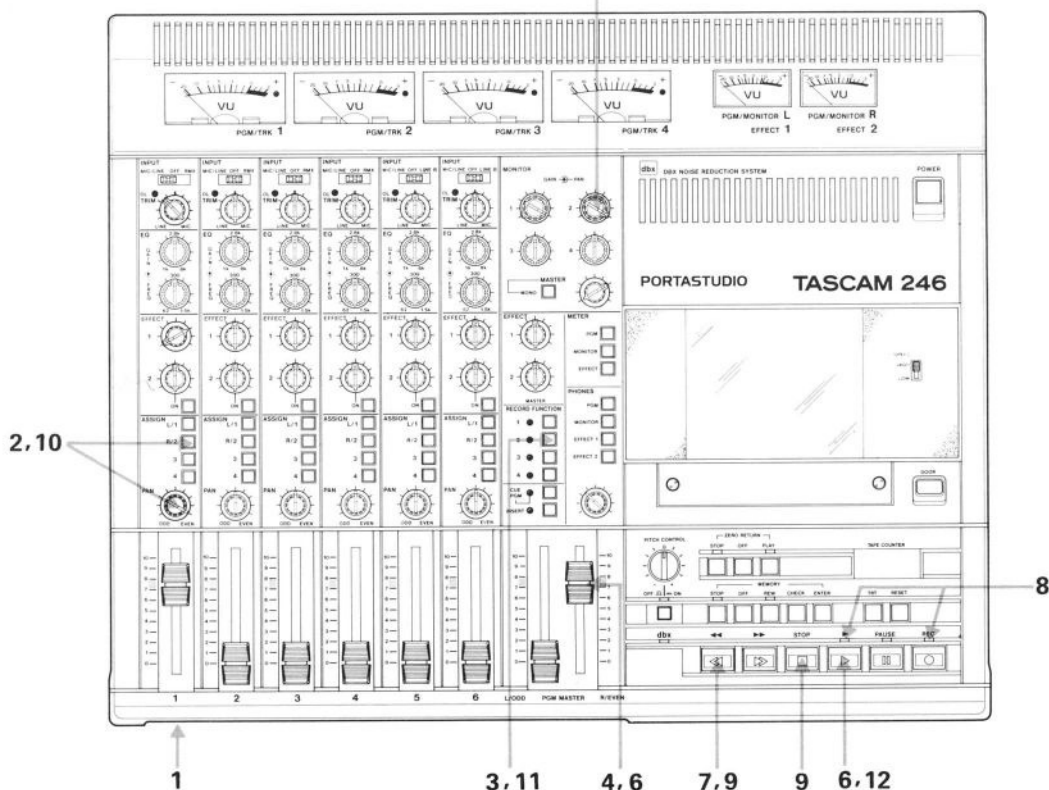

# Ping-Ponging, Collapsing, or Bouncing Tracks

The recording capability of the Portastudio is not limited to just the four tracks, however. As you progress with your recording, you will reach a point where you need more than four tracks. This is where ping-ponging, or bouncing tracks is invaluable. The process allows you to combine two or three tracks onto the remaining blank track while recording new material.

We will take the material you recorded on the first two or three tracks and collapse them to track 4.

1. Set the CUE/PGM switch to the PGM (down) setting. Its LED will light. Turn the INSERT switch off (up). The INSERT LED will be off.

2. Press the ASSIGN switch 4 in channels 1, 2, and 3.

3. Turn the PAN controls of channels 1–3 to the EVEN position, fully clockwise (right).

4. Place the channel faders 1–3 and the PGM MASTER R/EVEN fader as well into the shaded area between 7 and 8.

5. Set the INPUT switches for channels 1–3 to the RMX (Remix) position (right).

6. Press the number 4 switch in the RECORD FUNCTION section. Its LED will flash.

7. Turn MONITOR controls 1–3 off, all the way counterclockwise, and turn MONITOR GAIN 4 all the way clockwise.

8. Make sure the MONITOR switch in the PHONES section is down.

9. Play the tape, watching the PGM/TRK 4 meter. It should not register over the 0 level. Use the channel faders to get the proper balance and levels.

10. Rewind your tape to zero.

11. Press the RECord and Play buttons. Your first three tracks are now being recorded onto track 4.

12. When finished, STOP the recorder and turn off the RECORD FUNCTION 4 switch. Rewind the tape to zero.

13. Set the CUE/PGM switch to the CUE position. Play the tape, listening to the results via the MONITOR GAIN 4 control.

## Ping-ponging

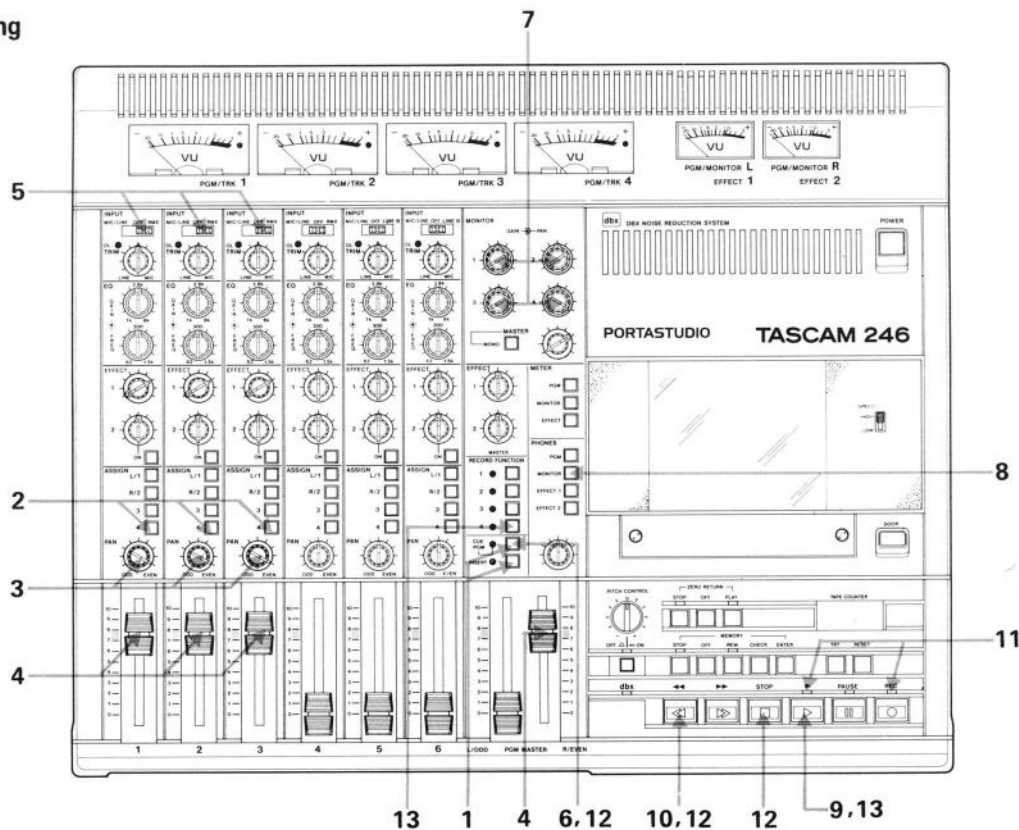

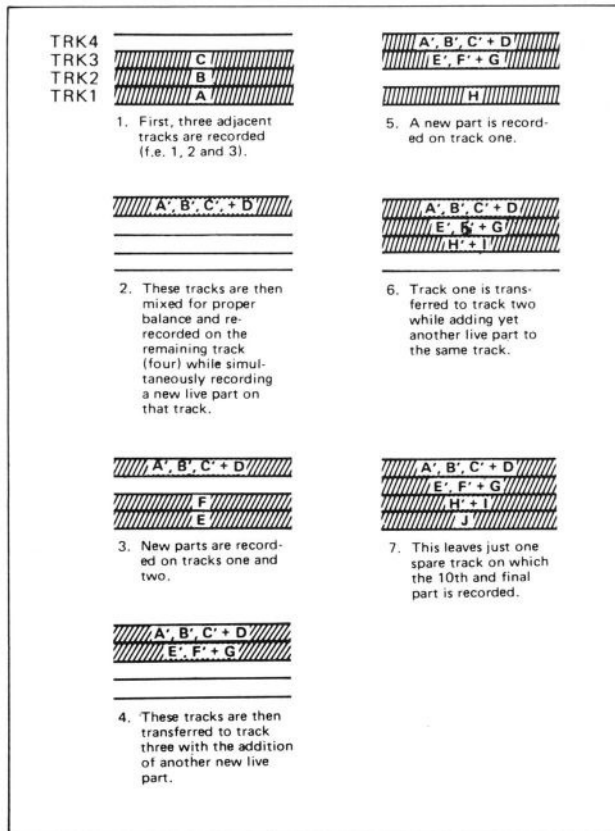

If you hear something that you don't like, you can redo the collapse. Make sure the results are what you want before you start using tracks 1 – 3 for new material.

It is possible to add a part during the ping-ponging process. You can use the input channels 4–6 for this. The process is a combination of procedures for Recording Our First Track and ping-ponging.

1. Set up the controls for the channels that you want to use for the new material (channels 4–6) as you would to record any new material: INPUT to MIC/LINE; EQ to desired settings; ASSIGN switch number 4 down; PAN to EVEN; and Faders to the desired levels.

2. Rehearse the new parts while listening to the previously recorded tracks. Use this rehearsal to set the appropriate levels for the new material.

3. Perform the remainder of the ping-ponging procedure.

# Remix or Mixdown

When your multi-track master (your Portastudio's tape with all four tracks filled) is finished, you will want to convert it to a stereo master. You will need another tape recorder for this process. Any stereo recorder with line inputs will do, but a quality recorder, such as those made by TASCAM or TEAC, will insure that you won't be stepping down in quality just because you're stepping down in quantity (tracks). Use TASCAM model 122 or equivalent recorders capable of high speed recording.

1. Connect the PGM 1/L and PGM 2/R OUTputs on your Portastudio to the Line Inputs of the mastering recorder.
2. Set the Portastudio's INPUT selector switches (1-4) to RMX.
3. Adjust channel and PGM MASTER faders to the shaded area between 7 and 8.
4. Press the number 1/L and 2/R switches in the ASSIGN section of channels 1-4.
5. Set the METERS, PHONES, and CUE/PGM switches to the PGM setting.
6. Make sure the RECORD FUNCTION switches are off (up) and their LEDs are off.
7. Rewind the tape to zero.
8. Press the Play button. Adjust the PHONES level control.
9. Use the PAN and channel fader controls to get the right stereo balance and levels.

10. Adjust the overall level using the PGM MASTER faders. Use your stereo VU meters to help you get the proper signal level (-3 to 0).

11. Rewind your tape. Put a fresh tape on the mastering recorder. Run the tape for fifteen seconds or so on the mastering recorder and reset the tape counter and zero return.

12. Adjust the level controls of the master deck by playing your Portastudio's tape and using the appropriate controls on the master. When you have finished, Rewind your Portastudio.

13. Put the mastering recorder into its record mode. This usually means pressing record and play switches at the same time. When your mastering machine is rolling, press the Play button on the Portastudio.

14. When finished, stop the tape recorders and listen to the master tape. If you aren't satisfied with the results, repeat the remix process.

You may use loudspeakers to monitor your Remix. Connect the MONITOR OUTputs to the auxiliary or tape inputs of your receiver or amplifier. Turn the MONITOR PAN control #1 fully counterclockwise and PAN #2 fully clockwise. Be sure the MONO switch is in the off (up) position.

## Remix

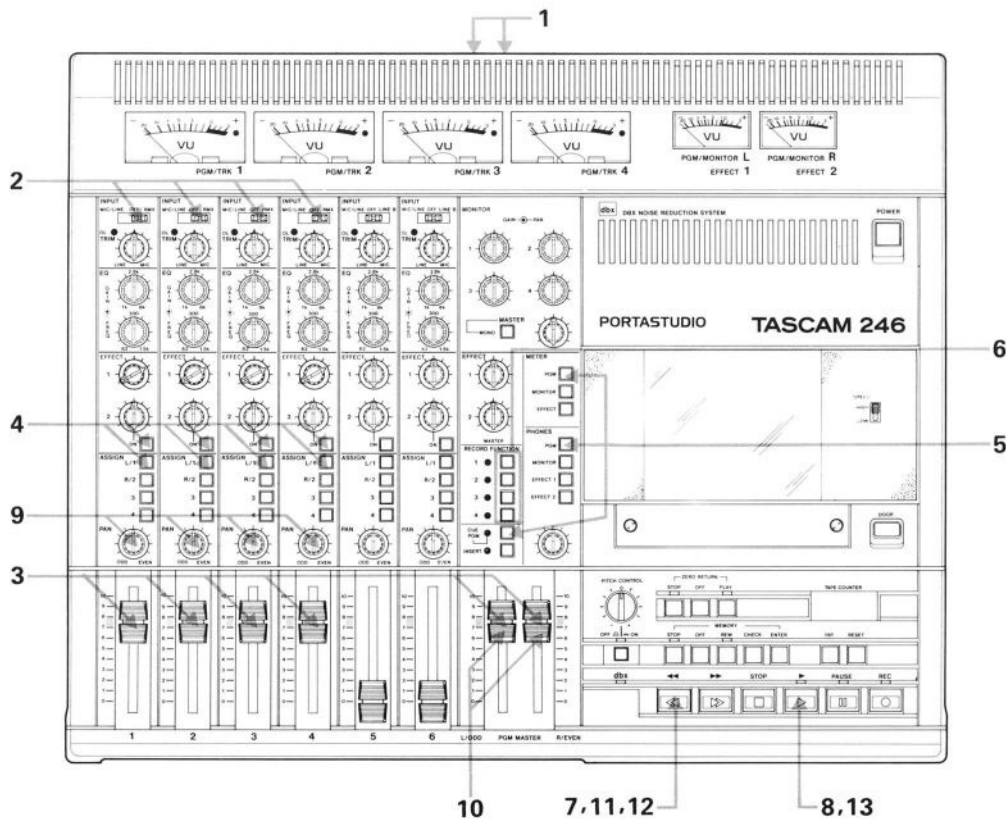

# Punch-In and Insert Editing

The Punch-in procedure gives you a way to add those last minute ideas to your recording. The artistic process doesn't end when the recording begins. Many times a way to improve your program will become apparent as it is being recorded. Punch-in can also be used to correct a mistake that made its way onto the tape.

Punch-in erases old tape material and puts new material in its place. This change is permanent, so it's wise to rehearse your Punch-in until you are confident that it can be performed correctly. We will give you the rehearsal procedure first.

1. Play the tape to within several seconds of the desired edit/Punch-in point.
2. Make sure the TRT switch is in the off, up position, and press the RESET button.
3. Set the CUE/PGM switch to the CUE position.

4. Your new material will be coming from one of the INPUT channels of your mixer. Assign the appropriate PGM Buss and adjust levels.
5. RECORD FUNCTION switches should be off.
6. Play the tape, the reference tracks should be heard through headphones via the MONITOR section. Adjust the levels of the tracks using the MONITOR GAIN controls.
7. Rewind the tape, and play it again.
8. When you reach your edit point, press the RECORD FUNCTION switch for the track to be edited. You will now be able to hear the new program material through your headphones.
9. When the point comes to punch-out, end the edit, press the RECORD FUNCTION switch again. This will return the monitor to the tape signal.
10. Repeat the procedure until you are comfortable with the process.

## Rehearsing a Punch-in

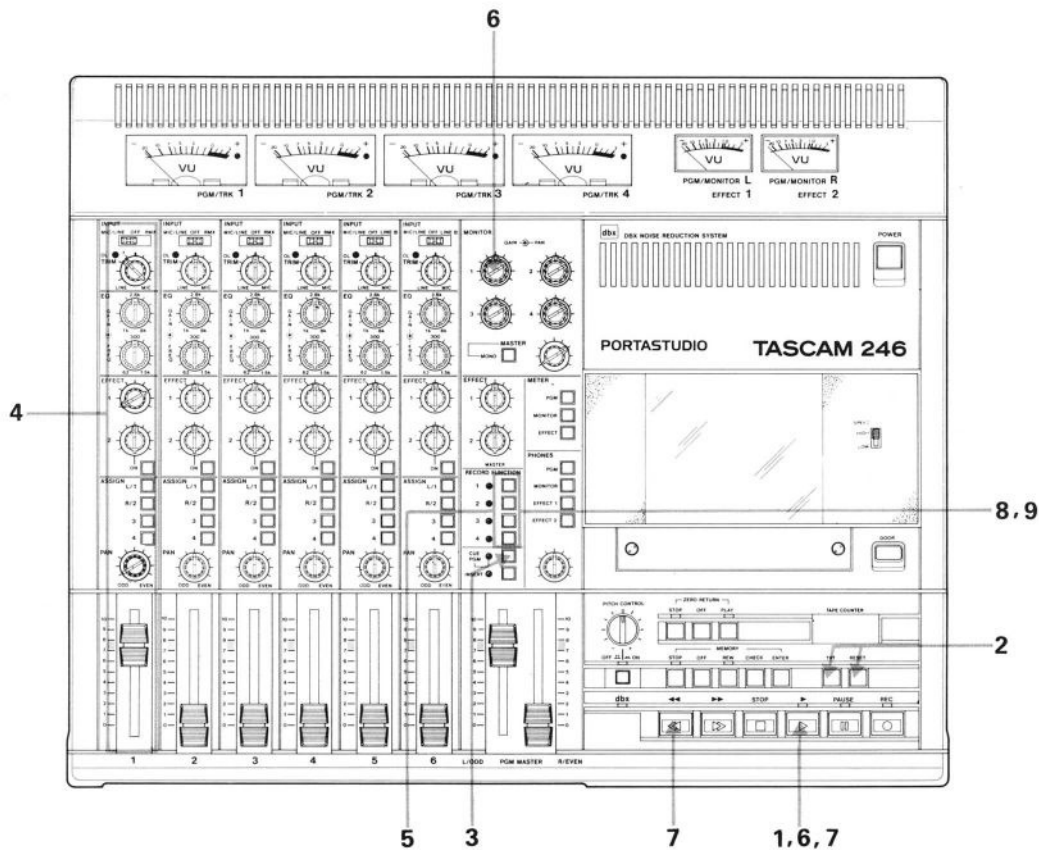

## The Actual Punch-In and Punch-Out

1. The INSERT switch should be in the on (down) position. Its LED will be on. The CUE/PGM switch remains in the CUE position.
2. Press the appropriate RECORD FUNCTION switch.
3. Make sure the RECORD FUNCTION switches for the uncorrected tracks are off (up) and the LEDs are not lit.
4. Make sure that the PHONES select switch is set for MONITOR.
5. Press the Play button.
6. Just before you reach the edit point, at the point you've decided upon in your rehearsals, press RECORD.
7. When you reach your Punch-out point, press STOP, Play, or Rewind buttons turning off the record mode.

## REMOTE Punch-In/Out using the RC-30P Pedal

Rehearse in the same way as you did before. When you're ready to go . . .

- 1) Start the recorder rolling by pressing the Play button. The RECORD FUNCTION switch should be on, with its LED blinking.
- 2) When the predetermined Punch-in point arrives, step on the RC-30P pedal. This will start the RECORD process, the LED will stay on continuously.
- 3) When the Punch-out point arrives, step on the RC-30P again. This will stop the procedure, the LED will start blinking.

## Actual Punch-in

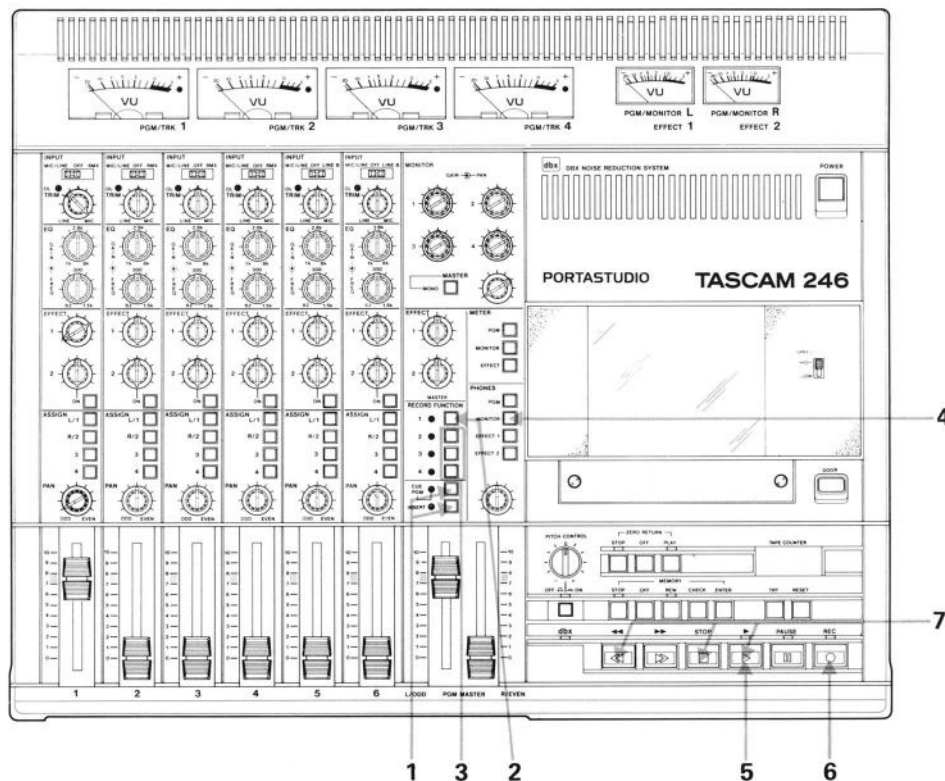

# Work Methods: Getting a Satisfactory Recording

As we mentioned on the first page of this manual, recording is an art as well as a science. Art has a special and intangible quality that sets it apart. In order to create art, the artist must have the proper tools, command of the techniques of those tools, and a healthy dose of inspiration. Your Portastudio is the tool. The command of the techniques will involve some practice and some thought on your part.

The following paragraphs are here to provide you with information, suggestions, and some perspectives regarding the recording process and your Portastudio. There are three fundamental notions upon which these suggestions are based, they are: Planning, Apparent and Absolute Values, and Common Sense.

## PLANNING

Planning is an obvious necessity when considering how many tracks your recording will require, when you intend to ping-pong, remix, etc. Track sheets are handy sketch pads that will aid you in the planning of your recording process.

Plan your recording environment. You will need a room that is quiet and has sufficient electrical power. If there are appliances or air conditioners plugged into the same circuits as your Portastudio, they will probably cause hum, clicks, or other noises when their motors come on. Once you have your location picked out, you will need to make it ready. You will find a lot more helpful material in the "Multitrack Primer" available from TASCAM.

All your instruments should be in proper condition. They should be adjusted. Does your guitar need new strings? Is the piano in tune? And how about your microphones and cables? They need to be working properly. Are they the right microphones for the job?

Should you be using direct boxes or input transformers? Microphones and magnetic pickups (those of guitars and basses) have a very low signal level. As a result, they are very susceptible to the effects of radio frequency noise. Using cables that are over ten feet in length makes this problem more severe. Direct

RECORDING								
CLIENT _____	DATE _____		REEL _____		OF _____			
ARTIST _____	_____ IPS _____ TRACKS							
PRODUCER _____	TAPE _____		<input type="checkbox"/> DBX		<input type="checkbox"/> TIME CODE			
ENGINEER _____ 2nd ENGINEER _____	<input type="checkbox"/> MASTER		<input type="checkbox"/> COPY					
TITLE _____	1	2	3	4	5	6	7	8
_____								
TITLE _____	1	2	3	4	5	6	7	8
_____								
TITLE _____	1	2	3	4	5	6	7	8
_____								



boxes and input transformers can be used to improve the quality and quantity of the input signal. TASCAM model 109B Input Transformers are available from your dealer. Keep cables as short as possible.

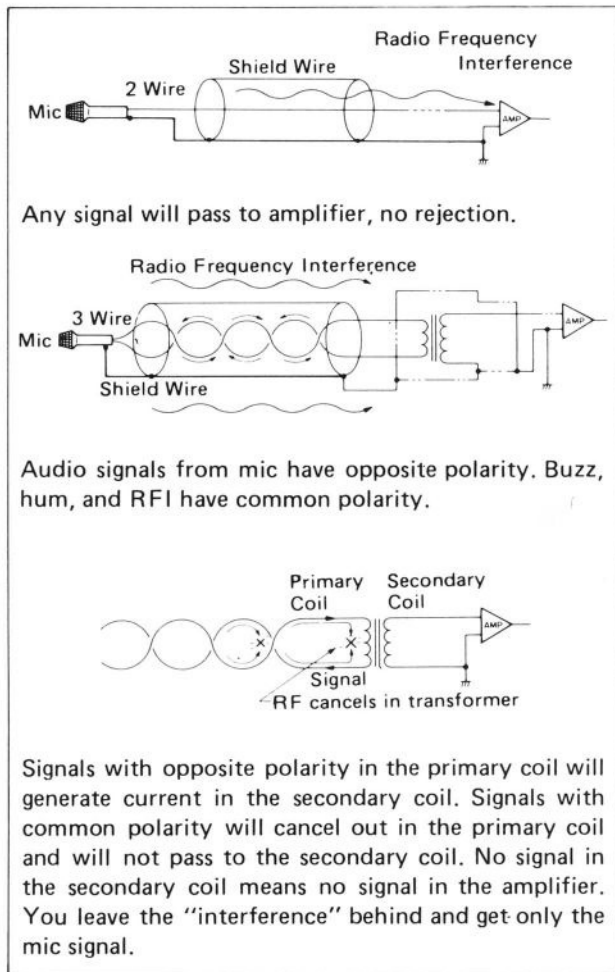

Do you intend to use timing codes of some sort; SMPTE, FSK, or some other data code? These codes should be recorded first onto track four without dbx. dbx can make certain data codes unstable and unreadable. The codes themselves should not be put through your mixer system. Record them directly through the PGM Inputs. If these codes are recorded while other program material is also recorded, the timing codes may "leak" onto your other busses. A metronome or "click" track can be recorded while other sources are also recorded. If they "leak" onto the other busses, reduce their levels, or record them separately.

Do you need another monitor or cue mix? It is possible to use your EFFECT submix as a Cue mix. A Cue mix allows someone who needs an additional or different mix than that provided by the control room monitors to have it. If you use a channel of the EFFECT submix for a Cue mix, you won't be able to use it as an effect send and return. You will also need an additional amplifier for speakers or headphone amplifier such as the TASCAM MH-40B. Remember, never use a "Y" cord connected to either of the headphones jacks on your Portastudio, this will damage the electronics. So plan ahead. You could also use the PGM outputs for a Cue mix. And your EFFECT mix has other capabilities. As an example, you could use your PGM inputs as effect returns, if your effects have level controls. In this way you would free channels 5 and 6 of your mixer for other inputs.

Should you use another recorder, in addition to your Portastudio, to create your master tapes? The benefit of using a second recorder as a remix, or mastering, machine is that you may keep your original four tracks intact, instead of erasing and merging them through the ping-pong process. Record the master, remove your four track tape, record the master back onto two tracks of the Portastudio, and continue to build tracks. In the mean time, you have preserved your original four track master, in case you want to re-master them later.

The ability to understand the flow of signals through your 246 can be a very powerful weapon in your creative arsenal. This understanding allows you to maximize the features of your 246, find problems quickly, and, perhaps, come up with new applications. To help you in this understanding we have provided you with three types of illustrations: the first is a line drawing of the unit; the second is called a pictogram, which is a representation of the controls and features placed in the proper sequence of

signal flow; the third is a block diagram, which is the same as the pictogram using a different set of symbols for the individual features and controls. Learning to read a block diagram can be a tremendous help in your future dealings with audio equipment. An experienced studio engineer can usually operate even the most sophisticated equipment with only a block diagram as a guide.

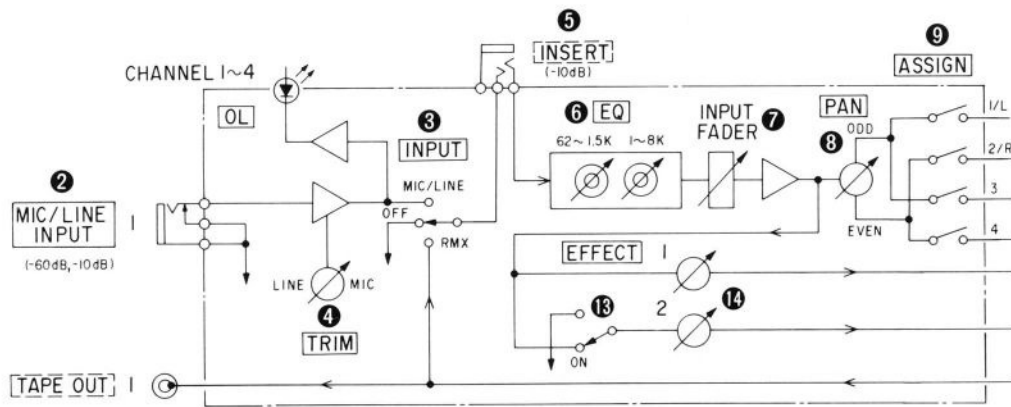
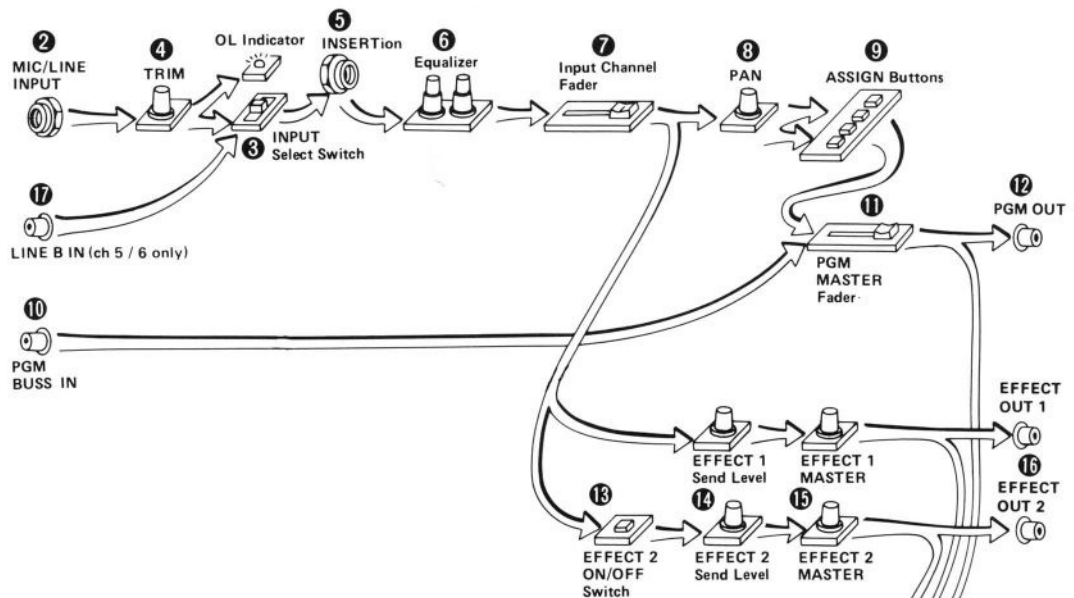
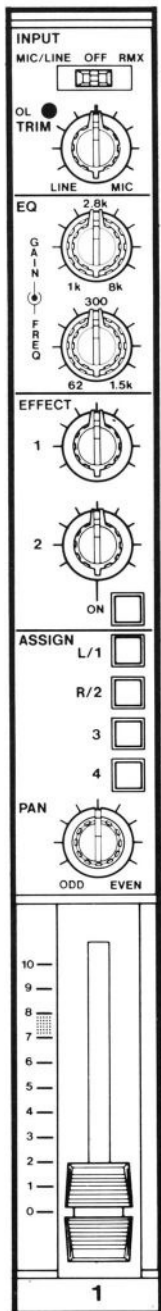

## APPARENT AND ABSOLUTE VALUES

The human ear and the Portastudio perceive the same program material in very different ways. The ear deals in apparent values while the Portastudio deals in absolutes. This leads to a fundamental rule: trust your machine, the meters, OL indicators, etc. during the recording procedures; and trust your ears during the playback and remix procedures.

The METERS show both the average program level with the needle of the meter and the peak program level and transients by means of peak lights built into the meters. Percussion instruments and synthesizers that use percussive sounds can be difficult to record properly. Believe your meters! Keep your levels under control when you record these instruments. Their apparent loudness is not usually greater than other instruments, but their absolute signal value is much higher than the average level. If these levels reach your tape without being trimmed, they will cause your sound quality to go down.

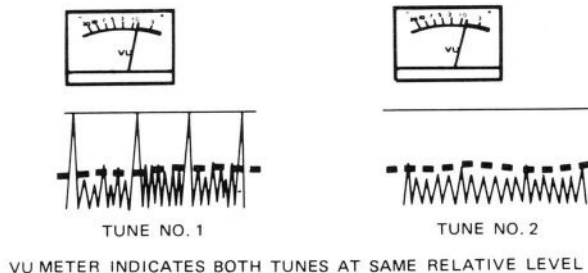
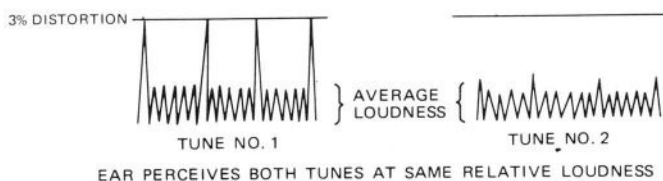
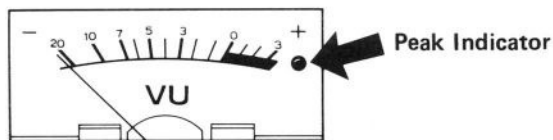

## THE 246'S EQUALIZER

EQ can be used to change the tonality of an individual instrument or track. The 1 kHz to 8 kHz control affects the "brightness" or "brilliance" of the timbre of the sound passing through it. The 62 Hz to 1.5 kHz control affects the relative "boominess" or "bassiness" of the sound. You will notice that there is some overlap in the functions of the two controls in the 1 kHz to 1.5 kHz range.

There are always at least two sides to every story. The EQ story is no different. The tone or timbre of the music on any track can be altered to bring about a similar change by using either EQ control. How so? Suppose you want to change the "balance" of the timbre by accentuating the bass. Before you reach for the 62 Hz — 1.5 kHz knob and start adding bass boost, consider reaching for the 1 kHz—8 kHz control and rolling off the highs a bit. These two vital controls epitomize the team work approach to problem solving. Always consider both alternatives whenever an EQ adjustment is necessary.

The EQ system in your Portastudio is a sweepable type that uses two frequency controls and two cut/boost controls. The frequency controls are continuously variable within their outside limits. These controls let you pick the specific frequency range that you want to adjust. The cut/boost portion of the EQ controls the amount of gain (boost) or attenuation (cut) that will be performed to the selected frequency range. How do you tell the frequency range that needs attention?

Most of us can tell that Michael Jackson's voice is higher than Bruce Spingsteen's. Or, if you prefer, consider the squeak of a mouse and the roar of the lion. These examples are extreme and, therefore, distinctions are quickly made. Consulting the chart provided on next page, you can see that Michael and the mouse will be much more affected by an adjustments in the 1 kHz frequency range than Bruce or the lion would be. Bruce and the lion will get more help from a control placed in the 440 Hz range. A bass drum will be more affected by the 62 Hz control than a cymbal.

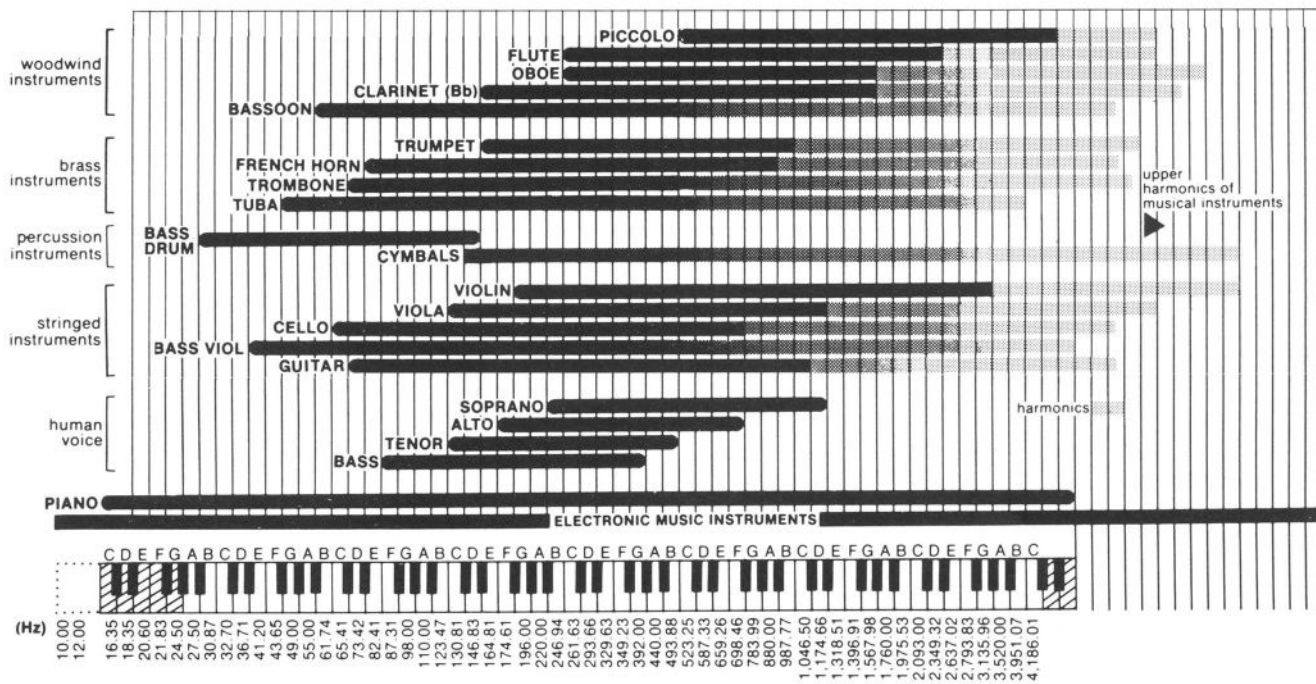
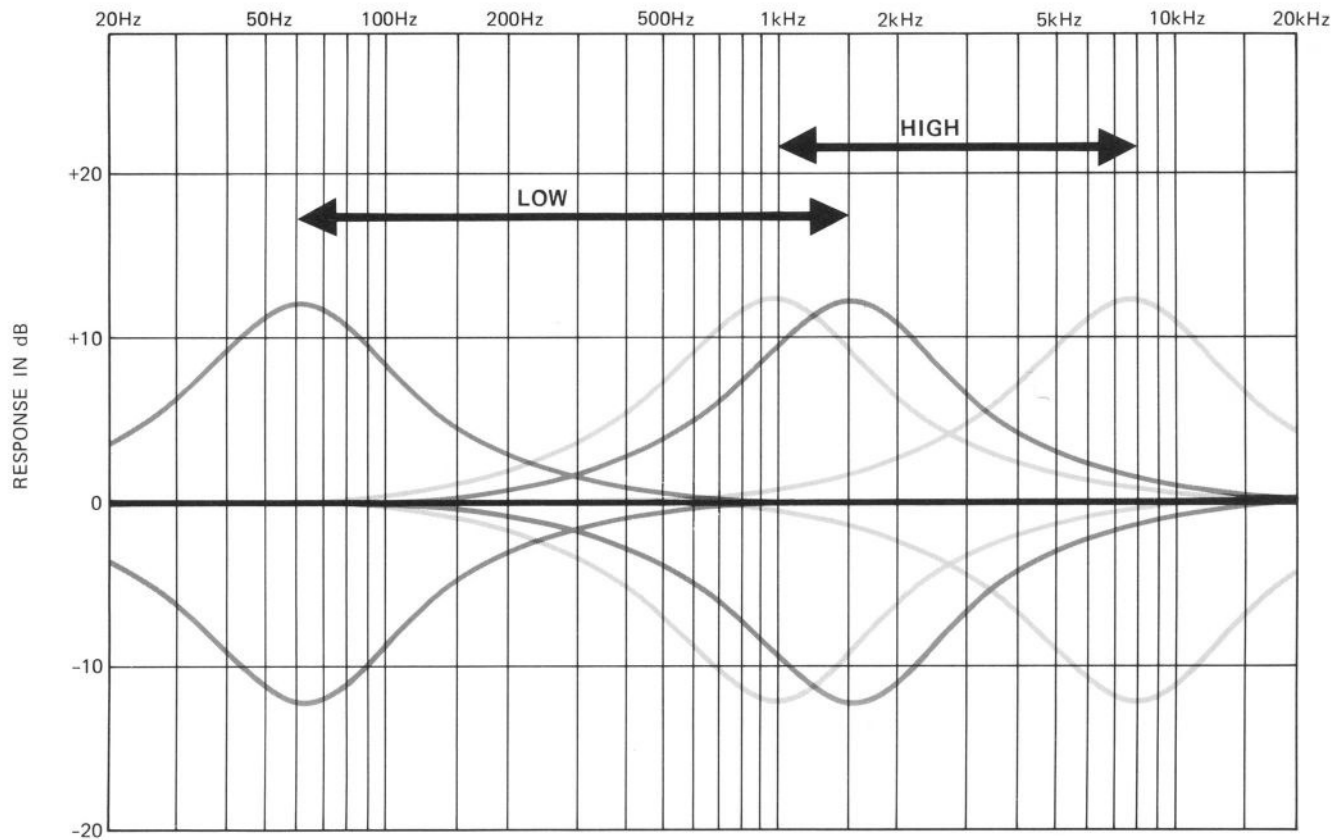

Once you have determined that 1) the signal does require EQ and 2) the proper frequency range has been identified, the final steps involve turning the proper controls. Sounds simple, doesn't it? There are still two controls to adjust in both the bass and treble (high) frequency ranges. To determine the proper frequency within the range of one of the controls, turn the Gain (boost) portion of the control to an exaggerated position, almost all the way up. Then, slowly sweep the frequency ranges by turning the frequency control from its minimum to maximum settings in a clockwise motion. As the control is turned, you will hear the change in the signal's content. When the desired frequency is isolated, set the Gain portion of the control to the necessary amount of boost or cut. Whenever possible, avoid making these changes during a performance or recording. The sweeping action can create undesirable timbral effects.

The illustration of the frequency range chart show how different instruments will be affected to differing degrees by a change in a specific range. Cymbals and flutes, for instance, would not be altered much by changes in the low frequency range. This is because these instruments have very little signal content in this range. On the other hand, the sweep capability allows you to boost or cut specific parts of signals or instruments without altering the sound of other signals. As an example, a bass drum can be brought out by carefully turning the low frequency section of the EQ until the sound of the bass drum is more prominent than other drums. The same technique can be used on vocals or any other element of a multiple mix of signals, as long as the various components occur in slightly different frequency ranges.

When EQing a track, remember that the control you use will affect all the music passing through the control's circuit. In the case that a single instrument is on a given track, this isn't a problem, but after ping-ponging, you may find that the necessary boost on one instrument also boosts another instrument on the track in an unfavorable way. Experience will help you learn the limits of the EQ process.

## A WORD OF MIXING ADVICE

All finished tapes must be balanced for level. Do all the instruments and voices blend together in a way that is appealing? Is the lion roaring so loud that the mouse is "lost in the mix." Your signal levels will affect the entire recording and mastering process, including the EQ process. So make sure that your levels are properly adjusted when recording, ping-ponging, and re-mixing. This will let you use your EQ system to "fine tune" the music. You can't fix it if you can't find it.

If your mixer's faders end up looking like this, then you're overloading your outputs. Pull down the input channel faders and raise the program master faders.

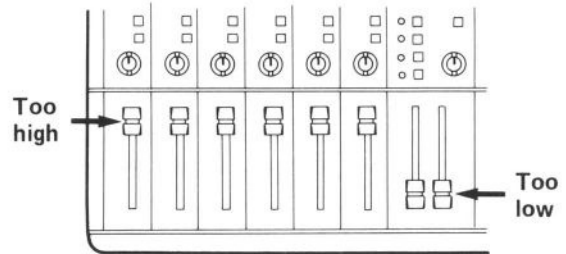

If this is the look your mixer is projecting, then you're pushing the master too hard. Your mix will be clean and undistorted, but will have a lot of noise in it.

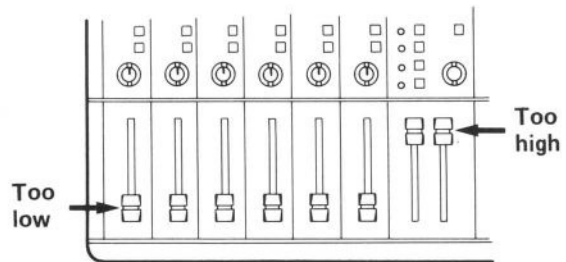

This picture is the reasonable compromise. It will give you the best results.

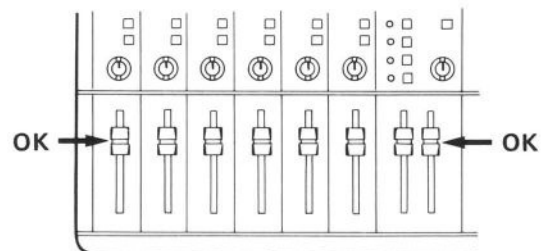

## COMMON SENSE: CARE AND MAINTENANCE

Even though the heads used in your Portastudio are constructed of very durable materials, they will show excessive wear much faster if they are not treated properly. If you follow the procedures listed here, you will get the most out of your Portastudio.

### CLEANING

You need some head cleaner (TEAC HC Series/TZ-261), some cleaner for the rubber components (TEAC RC Series/TZ-261), and some swabs. Cleaning procedures should be performed before each session, after each session, and whenever you're waiting for the drummer to return from a break. Do it! You won't regret it.

Here's why:

1. Dirt or oxide built-up on the heads will force the tape away from the head gaps that do the recording and playing back. A very small distance is all that's required to produce a noticeable reduction in the record and playback quality. All the money you've spent, and all the engineering expertise expended by TASCAM on your Portastudio can be wasted by a minuscule bit of dirt or oxide on the heads. Wipe it off with head cleaner.

2. Tape and the oxide on tape act very much like very fine sandpaper. They slowly grind down the tape path on your recorder. If you don't clean off these abrasives regularly, the wear will be quicker and it will be uneven. Uneven wear on the heads can be compensated for, to a certain degree, by electronic adjustments. Eventually, uneven wear will create notches that will cause your tape to "skew" and skip around on the tape head. This skew will cause the tape to wear unevenly, which will cause more uneven wear on the tape heads. . . A very nasty business. Eventually the only solution is the replacement of the tape heads and tape guides. This is very expensive, particularly when you add the cost of sub par tapes, sessions, and lost time. Being conscientious can more than double the life expectancy of your tape heads and guides.

### Cleaning

As we mentioned this should be done every chance you get. Using TEAC HC Series/TZ-261 head cleaner and a cotton swab, clean the heads, capstan, and tape guides until the swab comes off clean. Wipe off any excess cleaning fluid with a dry swab.

Clean the pinch roller at least once each day the recorder is used. Use TEAC RC Series/TZ-261 rubber cleaner.

1. Open the cassette door.
2. Press the Play button and hold down the cassette-in-place sensor.

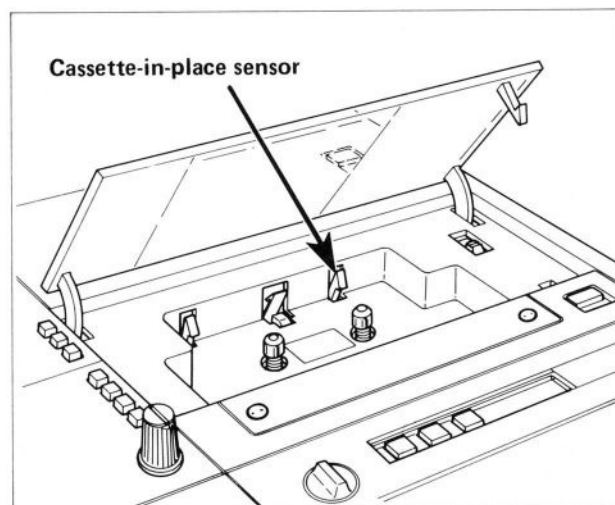

3. Press a cotton swab that has been moistened with rubber cleaner to the pinch roller on the right hand side of the capstan shaft. This will prevent the swab from becoming tangled in the mechanism.
4. Clean it until there is no visible residue coming off onto the swab.
5. Using a clean cotton swab, wipe off all the excess rubber cleaner from the pinch roller. Make certain that there is no foreign matter remaining on either the pinch roller or the capstan shaft.
6. Clean the capstan shaft by lightly pressing a cotton swab moistened with head cleaning fluid onto the shaft. Clean thoroughly and wipe off excess fluid.

---

## DEMAGNETIZING (DEGAUSSING)

A little magnetism is deposited on the heads every time a tape passes over them. It takes a very small amount of this magnetism to have a noticeable effect on performance efficiency. Playing ten cassette tapes will deposit .2 Gauss on the heads. Gauss is the unit used to measure magnetism. As little as .7 Gauss will cause erasure of the high frequencies on the tapes that pass by it. If you don't want your tapes damaged, then demagnetize regularly with the TEAC E-3.

Degaussing is always done with the Portastudio's power OFF. If you try it with the electronics on, the current pulses produced by the degausser will appear to the heads as an audio signal. These pulses are around 10,000 Gauss, and they will seriously damage the unit's electronics and meters. Turn off your Portastudio and turn on the demagnetizer at least three feet (1 meter) from the Portastudio.

If you are not using the TEAC E-3, or equivalent, be certain that your degausser has either a plastic cover or plastic tape covering its tip. Make sure that no metal ever touches the tape heads as it will scar them beyond repair.

Slowly move the demagnetizer into the tape's path. Move the degausser up and down, touching lightly all the metal parts in the tape's path. Slowly move it away again to at least a three-foot distance before turning it off.

Be sure to concentrate while you are degaussing. If you are not wide awake during this procedure, you can permanently damage the heads of your recorder. The demagnetizer will put a magnetic charge onto the heads if it is turned off or on while near them. This charge cannot be removed. Your head is a goner. So perform these functions with the respect, attention to detail, and regularity they deserve and your Portastudio will respond with the excellent performance both you and TASCAM expect.

**CAUTION:** Do NOT use paint thinner, benzine, alcohol, or other solvents that are not designed for the purpose at hand. These foreign substances will damage your Portastudio.

## TAPE HANDLING AND STORAGE

Tapes should be stored in a dust-free environment that won't be subjected to extreme heat or cold. Your tapes are a magnetic storage medium and can be damaged by things that generate magnetism. Electric motors, the kind found in vacuum cleaners and other appliances, will damage tape if they get too close to it. Make copies of your tapes so that if one is lost or damaged you will have a spare.

# Applications

The following are intended only to serve as examples. They are not the only way to do things. As you become more familiar with your Portastudio you will find alternate methods which may better suit your needs. Basic recording set up has been covered in the operational chapters of this manual ("Recording the First Track", etc.). For this reason, we will show you electronic music studio, and video applications. Remember to make all your connections with the Portastudio's power off.

## ELECTRONIC MUSIC STUDIO

When setting up a system of this type, the first thing to do is to put the speakers and amplifiers in their proper positions. Then wire each system. Make sure the 246's faders are down and the power on all units is off. When all systems are wired and your mics and instruments are connected, begin turning on the system. Turn on electronic instruments first,

followed by your Portastudio, then monitor and headphone amplifiers.

With the faders still down, set all EQ controls to their center, flat position. Set the channel input selectors to the appropriate positions, MIC/LINE on channels 1-4 and LINE B on 5 and 6. Assign the PGM Busses to the appropriate tracks of the recorder and raise the PGM MASTER Faders to the 7 position. Slowly raise the channel faders. If the levels of any of these channels is too high, as indicated by the meters or OL lights, then use the TRIM control to bring it down. If this is done and the channel fader must be kept below the 5 setting, then turn down the volume controls on your instruments or use a less sensitive microphone. The TRIM control will not work on channels 5 and 6 in our example because the selection of LINE B bypasses the TRIM. Therefore this level should be adjusted with the EFFECT 1 and 2 controls (in the effect send channels).

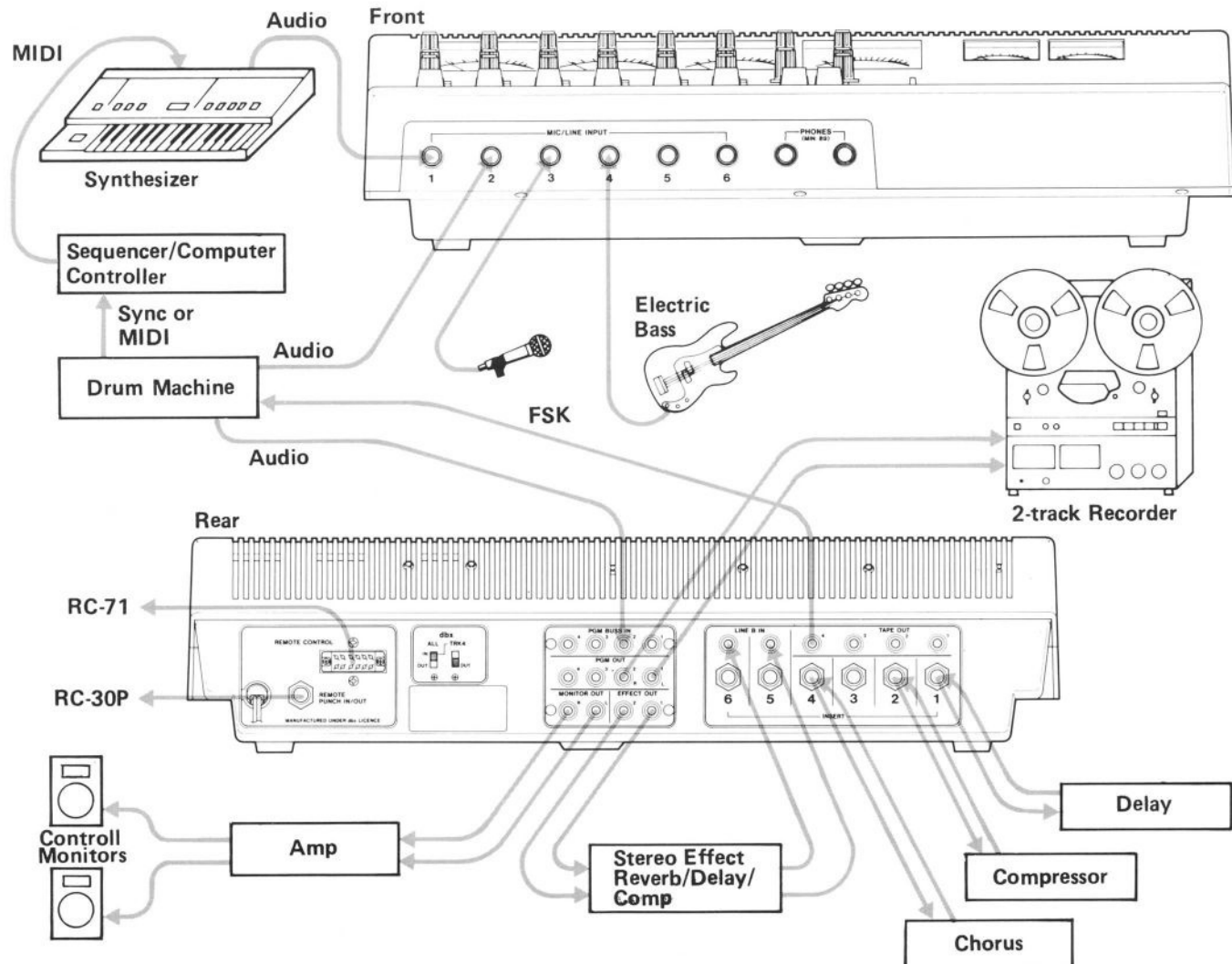



Setting the levels for the control room monitor speakers is a similar procedure. Begin by turning all MONITOR GAIN controls 1–4 fully counterclockwise. Next, set the MONITOR PAN controls 1 and 2 to the 12 o'clock position. Set the MONITOR MASTER control to the 2 o'clock position. Press the MONITOR switch in the METER section. Then, watching the small meters, raise the MONITOR GAIN controls by turning them clockwise, until the proper level is registered on the meters. If howling or feedback occurs, reduce the MONITOR MASTER level and reposition the speakers or any open microphones. You may have to experiment with the relative positioning of microphones and loudspeakers in order to find the best solution.

## VIDEO POST PRODUCTION

The 246 Portastudio has all the features necessary to fulfill the audio control needs of the off-line editing/sweetening facility. Virtually all popular brands and models of 3/4 inch and 1/2 inch VCRs will interface directly with the 246.

Stereo and mono audio signals originating from VCRs, voice-over mics (VO), audio cassettes or "cart", and any mic or line sources

can be mixed simultaneously using the 246. The mixed signals can then be assigned to the L and R PGM OUT jacks that will feed the edit master VCR. Since the 246 has four PGM OUT busses, a mix-minus master may be simultaneously recorded by the Portastudio using the unused PGM busses 3 and 4, with the ASSIGN switches 3 and 4 of the VO's channel off. This prevents VO signal from reaching the 3 and 4 busses so that this mix minus narration can be used for later dubbing in a second language.

Either of the EFFECT OUTPUTs can be used for cueing the voice-over announcer, while the other can be used for creating a side-chain for special effects with the PGM BUSS IN jacks.

In the example shown, two stereo source VCRs are shown in a typical A/B roll editing situation. A voice-over mic is running through input 6. A cart or cassette machine could be connected to input 5 if needed for hot rolling effects in the mix. If the mix-minus does not need to be cut, the Portastudio's recorder is available for reproducing effect cassettes. Remember that, because of the one-way record format of the Portastudio its tracks 3 and 4 should be disconnected from the ReMiX system when a two-way, general stereo cassette is played back.

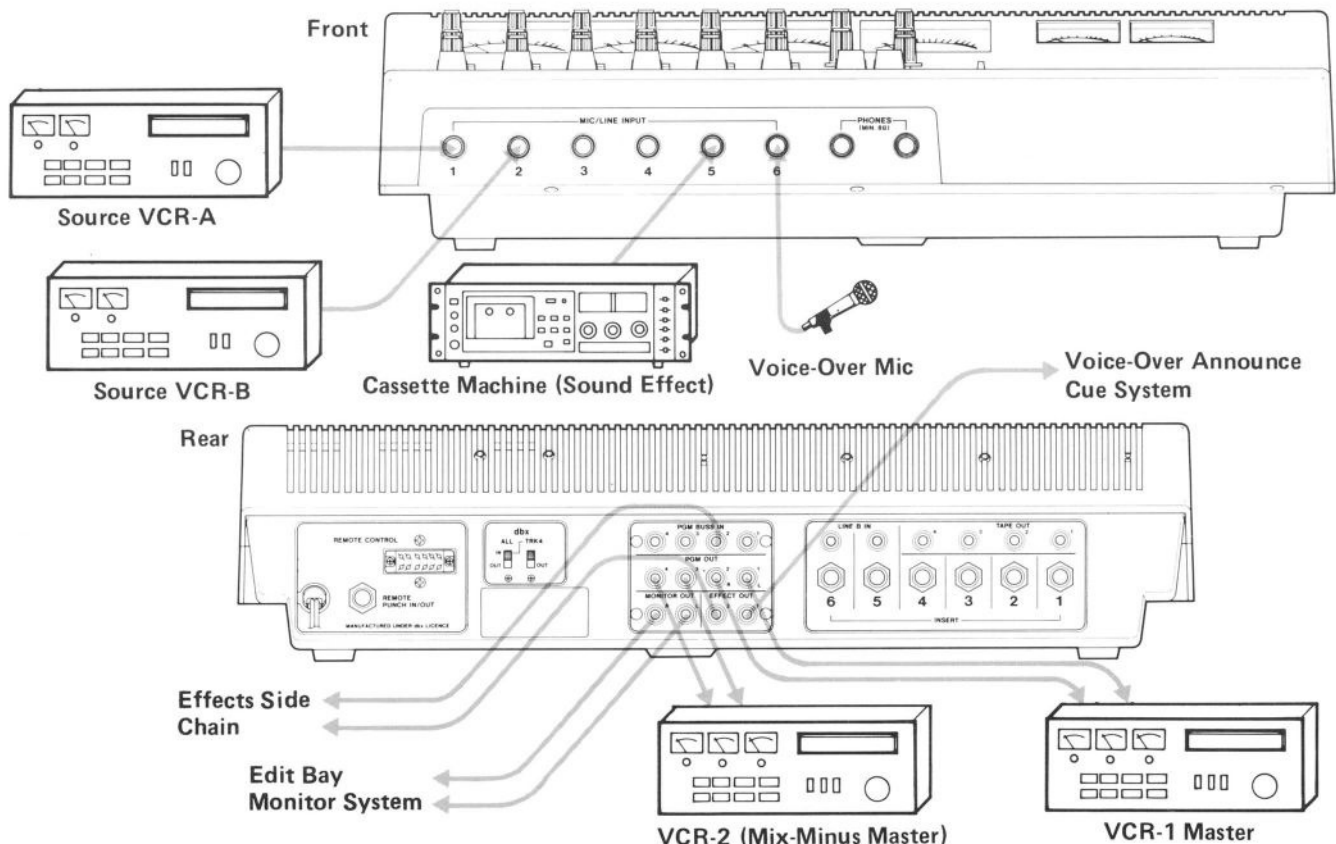

# Features and Controls

## MAIN MIX System

### 1 POWER

The POWER switch on the top panel turns the Portastudio on and off. The AC value of your Portastudio should be checked for compatibility with your countries AC. See the Voltage Conversion section of the manual page 39.

### 2 MIC/LINE INPUT Connectors

These quarter-inch phone jacks on the front panel will accept unbalanced signals from almost any type of microphone as long as the impedance is within the range of 150 ohms to 10,000 ohms. The impedance of a microphone can be found listed in its packaging. Sometimes it is even stamped on the mic itself.

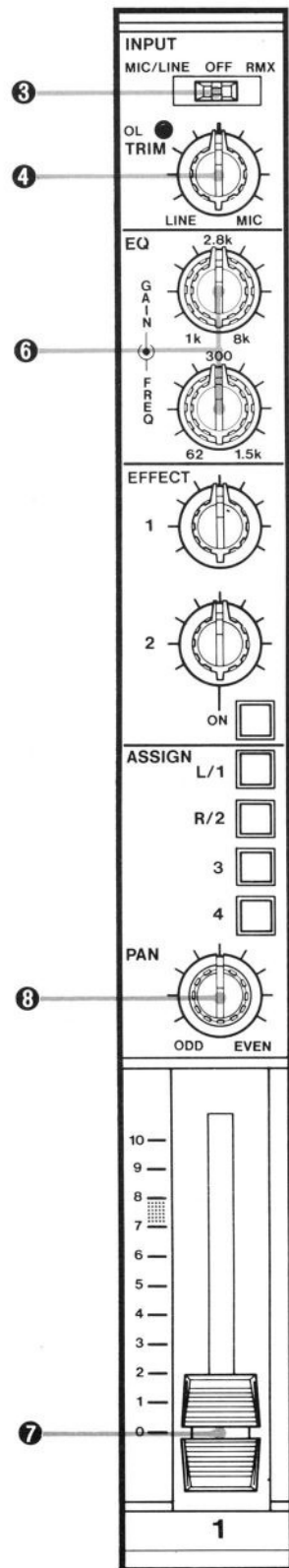
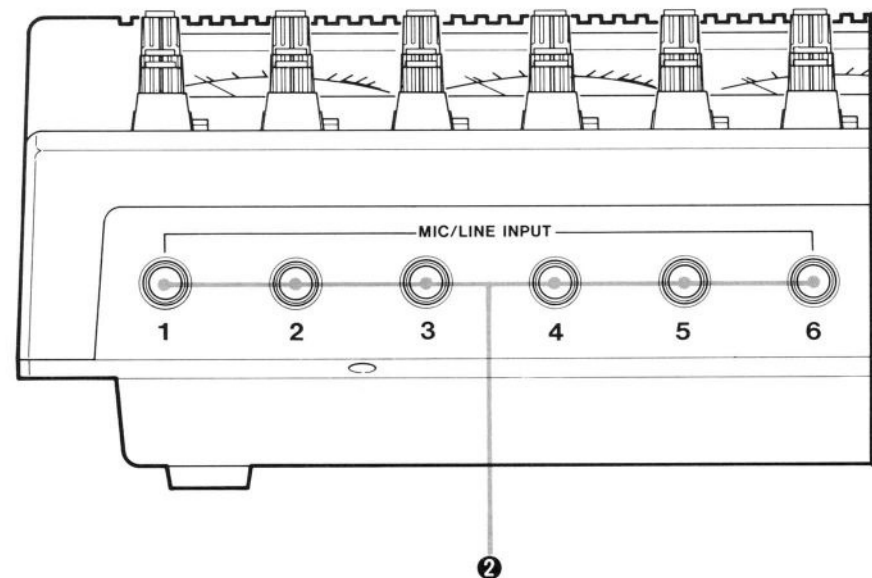
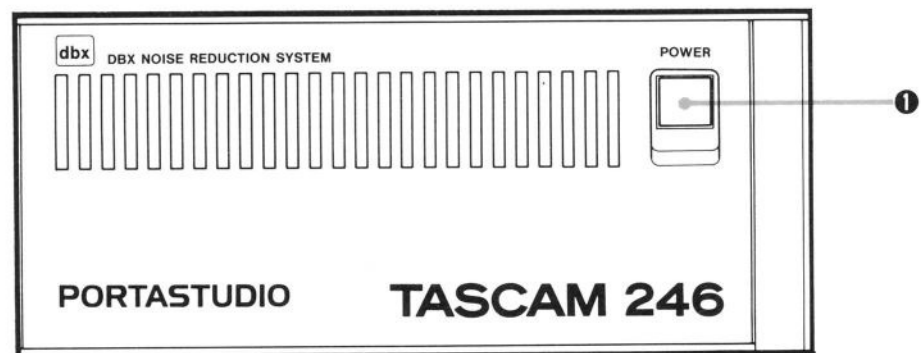

### ③ INPUT Selector Switch

These are found on the front panel, at the top of each channel of your Portastudio's mixer. The switch has three settings:

Left: MIC/LINE, Selects the MIC/LINE INPUT connector on the front panel of the Portastudio.

Center: OFF, Acts as a "mute." This mute can be useful in many ways. When used on MIC/LINE signals, it will allow you to turn on a signal accurately without having to move the fader. This "drop-in" function with all controls preset can be used to edit out undesirable sections of a track when you are remixing. Prior to your final mix, the use of this mute function will allow you to hold all your preliminary mix settings, including the level set by the fader; and to silence an input while you "fine tune" another.

Right: ReMiX channels 1 – 4, Selects an internal connection from the recorder's input channel 1 corresponding to tape track 1; channel 2 to track 2; channel 3 to track 3; and channel 4 to track 4. Nothing will be available at this switch point unless there are signals on the tape. The tape signal will also be present at the RCA connectors marked TAPE OUT on the back panel.

Right: LINE B channels 5 and 6, Selects the LINE B INPUT connectors on the back panel.

### ④ TRIM Controls and OverLoad Indicators

These features only pertain to the signal

coming from the MIC/LINE INPUTs. The OL lets us know if the incoming signal is too hot. Use the TRIM to adjust the incoming signal to a level that does not register, continuously, on the OL indicator.

### ⑤ INSERTion Jacks

The INSERTion jack is a three conductor (tip, ring, sleeve), quarter-inch, phone connector that gives you electronic access to the input channel's signal path. This access allows you to add signal processing (Compression, Flanging, Digital Delay, etc.) to an individual channel without affecting the other channels' signals. Use the TASCAM PW-2Y/PW-4Y Insertion Cable.

### ⑥ EQualizer

The EQ of your Portastudio is a "Sweepable" equalizer system that allows you to select the frequency range that you wish to change and the degree that it will be changed. For more information, see the Work Methods section of your manual page 19.

### ⑦ Input Channel Faders

This linear, slide, fader varies the amount of signal going to the PAN control, the EFFECT submix, the ASSIGN switches, and the PGM MASTER Faders.

### ⑧ PAN Control

This control allows you to create stereo mixes by sending your input signal in continuously variable degrees to the left (Odd tracks 1 and 3) or right (Even tracks 2 and 4) sides of the mix.

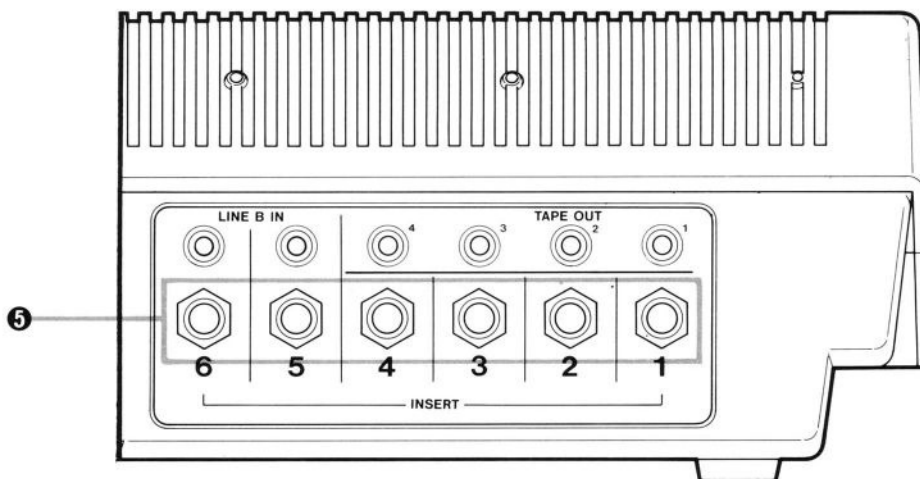

## 9 ASSIGN Switches

These four switches are used to send (assign) a signal to any one, or any combination of all four PGM Busses. The signal is also sent to the PGM MASTER Faders, the PGM OUTPUT, the inputs of your MONITOR submix system, and the recorder. These switches work in conjunction with your PAN controls, which decide how much (to what degree the) signal goes to the left (odd, 1 and 3) or right (even, 2 and 4) busses.

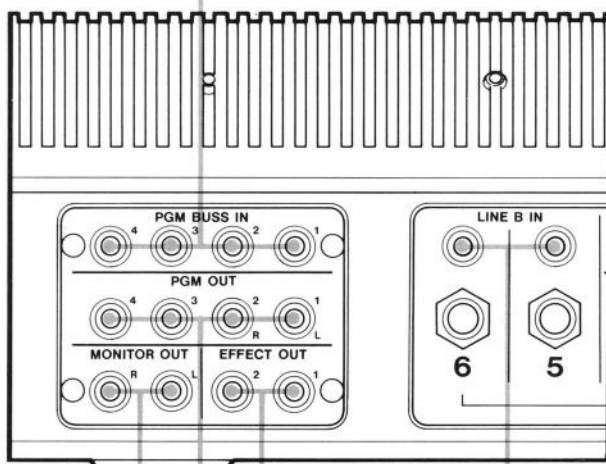
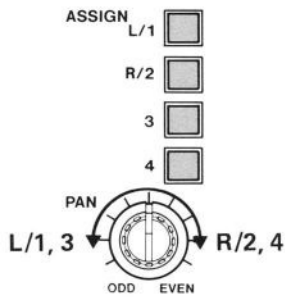
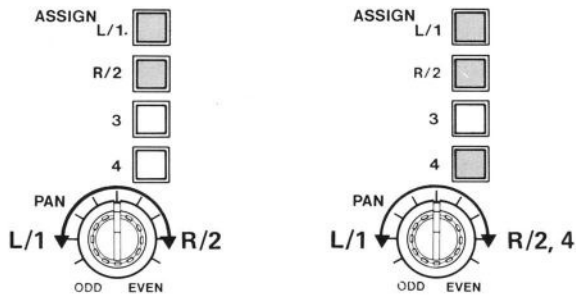

21 12 16

17

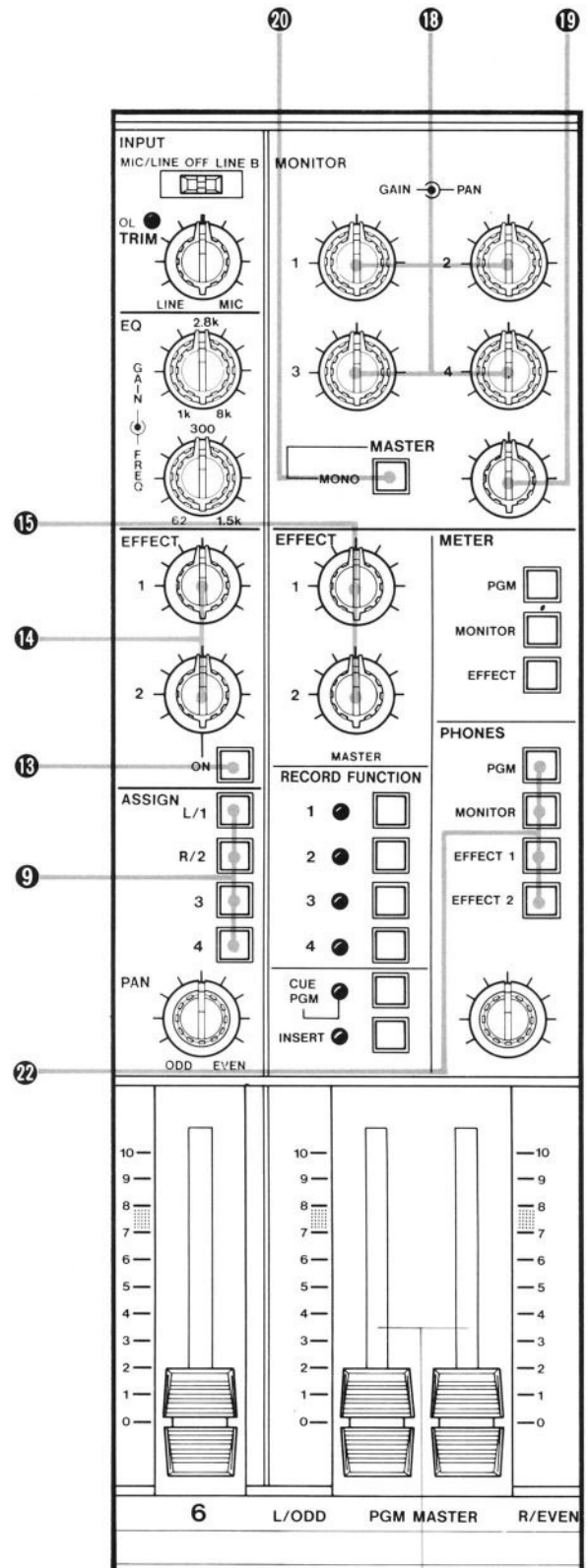

15

14

13

9

22

20

18

19

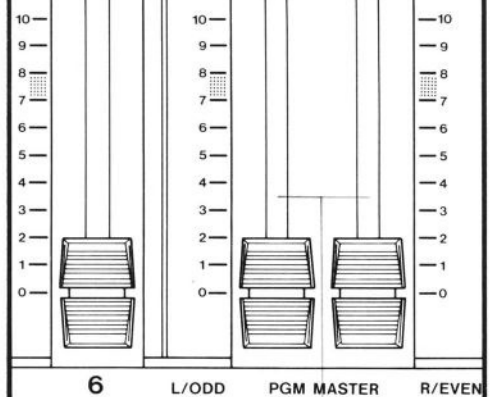

6 L/ODD PGM MASTER R/EVEN

11

## 10 PGM BUSS INputs

These connectors are on the back panel of your Portastudio. You can connect the line outputs of another tape recorder (up to four tracks) or, perhaps, another mixer that you might be using as an independent submixer. These inputs are after the PAN, channel fader, input to the EFFECT submixes, and the Buss Assignment switches. They are routed (sent) through the PGM MASTER Faders, the PGM OUTputs, and the MONITOR submixer system of your Portastudio. They will be recorded, along with signals from your six input channels by your Portastudio's tape recorder.

## 11 PGM MASTER Faders

Located right after the ASSIGN switches, the two PGM MASTER faders each adjust the level of two PGM Busses (L/Odd 1 and 3, R/Even 2 and 4) that are sent to the PGM OUTputs on the back panel, to the inputs of the MONITOR submix system, and to the recorder.

## 12 PGM OUTputs

These RCA connectors are located on the back panel of the Portastudio. Should you want to record on a different machine or use the Portastudio as a submixer, these outputs supply the access. These connectors provide a line level signal.

## EFFECT Submixer System

### 13 EFFECT 2 ON/Off Switch

This switch connects the signal in a channel to the EFFECT 2 Submix at a point after the channel fader and before PAN and ASSIGN. The signal is then sent to the rotary control labeled EFFECT 2.

### 14 EFFECT 1 and EFFECT 2

These rotary level controls determine how much signal will go to the EFFECT MASTER control.

### 15 EFFECT MASTER

These two controls adjust the overall level of the summed (total number added together) signals from the individual channels' EFFECT 1 and EFFECT 2 controls. From here, the signal goes to the PHONES Select switches, the METER Select switches, and the EFFECT OUTs.

## 16 EFFECT OUTputs

The signals supplied at the EFFECT OUT connectors are taken to a signal processor (reverb, delay, phaser, etc.) so that they can be enhanced in some way. After the signal is processed, they return to the 246 via the LINE B INputs on channels 5 and 6.

## 17 LINE B INputs as Effect Returns

The advantage gained by using the LINE B INputs of channels 5 and 6 to receive the returning signal from your effects is that you will be able to use the EQ, Fader, and PAN controls of those two channels to reshape the returning signal. CAUTION: Be sure that the EFFECT controls in channels 5 and 6 are turned fully counterclockwise, or, as for the EFFECT 2 you can use its on/off selector instead.

## MONITOR Submixer System

### 18 MONITOR GAIN and PAN Controls

There are four sets of controls, one for each PGM buss or recorder track, in your Monitor submix. There is a GAIN and PAN control for each of the four. As in earlier systems, these controls adjust the level and stereo positioning respectively. The signal is then sent on to the Monitor MASTER control.

### 19 Monitor MASTER Control

This is a level control that adjusts the stereo mix that goes to the MONITOR OUTputs. This control also adjusts the level of the signal that goes to the METER section (the stereo meters) and the PHONES section.

### 20 MONO Switch

This switch combines the left and right sides of the Monitor mix into a mono mix. It is often useful to hear what a mono mix sounds like.

### 21 MONITOR OUTputs

These are stereo outputs that provide a line level signal. They can be connected to an amplifier or receiver.

## PHONES Section

### 22 PHONES Select Switches

These switches let you listen to PGM L/R, MONITOR, EFFECT 1, or EFFECT 2 submixes.

**23 PHONES Level Control**

This adjusts the volume level that you hear in your headphones.

**24 PHONES Jack**

This is where you plug in your headphones on the front panel. There are two of these. Never use "Y" cords or mono headphones with these connections. To do so will damage the headphone amplifier circuits.

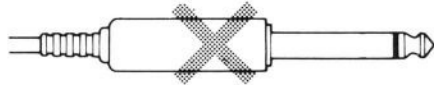

(1/4" phone 2-connector)



(1/4" phone 3-connector)

**Monitor Sources with PHONES Selector in MONITOR\***

CUE/ PGM/ Switch	IN- SERT Switch	RECORD FUNCTION Switch	Transport Control Switches			
			STOP	Play (▶)	REC/ Play(▶)	REC/ PAUSE
CUE (□)	Off (□)	Off (□)	—	TAPE**	TAPE	—
		On (▢)	PGM	PGM	PGM	PGM
	On (▢)	Off (□)	—	TAPE	TAPE	—
		On (▢)	—	TAPE	PGM	PGM
PGM (▢)	(in any positions)		PGM			

**NOTES:**

\*: Positions other than MONITOR have nothing to do with the setting of the switches shown in the chart.

\*\* : does not include TAPE signals in RMX (Remix) mode. (They pertain to "PGM".)

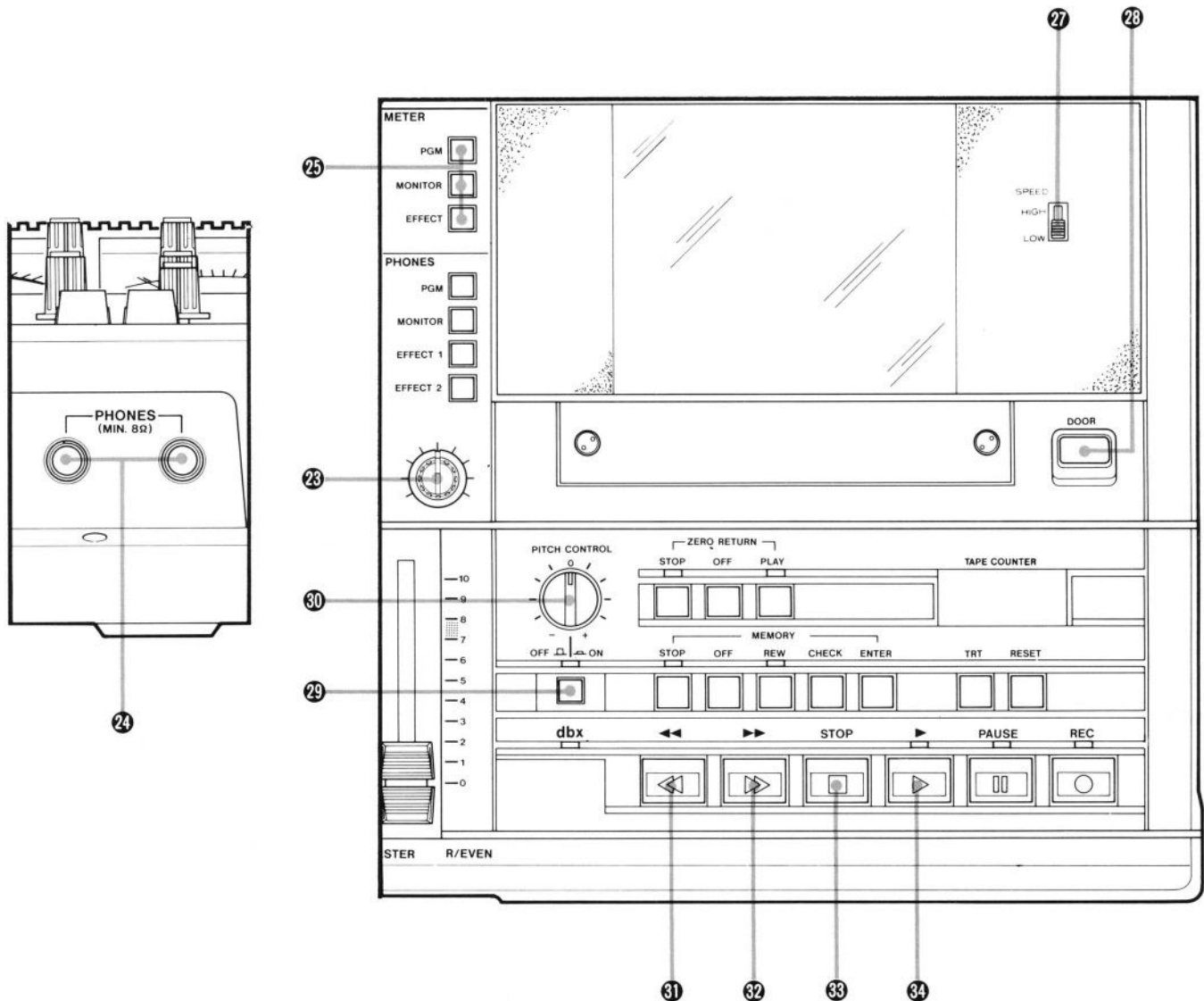

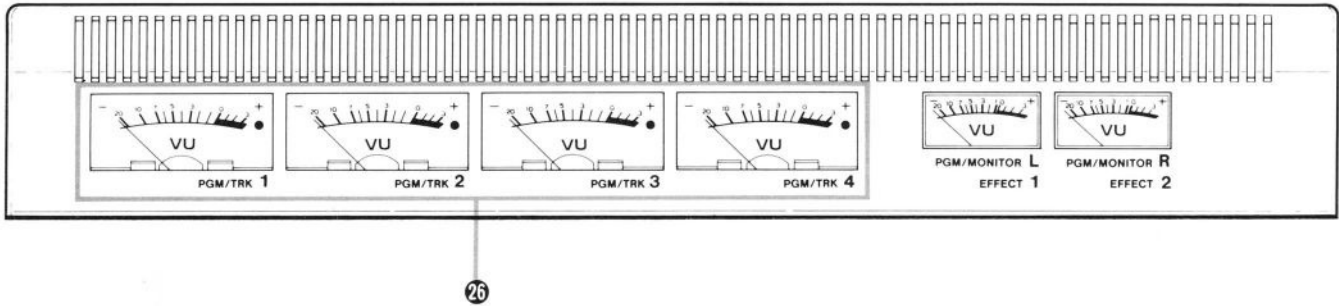

## METERS

### 25 METER Select Switches

These switches only affect the PGM L and PGM R meters. You can switch the meters to read the PGM Left and Right Outputs, the MONITOR Left and Right Outputs, and EFFECT 1 and 2 signals.

### 26 PGM/TRK Meters (1-4)

These meters have a logic system that automatically switches them so that they will display the appropriate signals. While you are recording your basic tracks, the meters will read the program material. When you switch the recorder to play mode, the meters automatically switch to read the TRAcK material. There is even a logic that lets the Meters switch back and forth during an INSERT recording. This logic lets you hear the tape or incoming signal while the INSERT switch is down and a Punch-in is in progress.

## The RECORDER

### 27 SPEED Switch

The recorder in your Portastudio will operate at two different speeds. The LOW SPEED setting runs at 1-7/8 inches per second (4.8 cm/sec.). The HIGH SPEED setting 3-3/4 inches per second (9.5 cm/sec.) will produce the best sound when recording.

### 28 DOOR Button

The DOOR button opens the door to the cassette compartment.

### 29 PITCH CONTROL ON/OFF Switch

This switch turns the PITCH CONTROL on and off. It is off in the up position. The transport's speed is then fixed at the speed determined by the SPEED control. It is on in the down position and its green LED will light.

### 30 PITCH CONTROL

This knob allows you to adjust the speed of the 246 Portastudio's by plus or minus 12% in either the play or record mode. You can use this speed control to accommodate minor changes necessary in the length or relative pitch of your program material. If you're making a 30 second radio spot and it runs a little long, you can speed it up enough to drop out the extra seconds. When tape runs faster than the speed it was recorded at, the material on it will raise in pitch. This can sometimes be used in a creative way to save parts that are a little out-of-tune, or to create sound effects. If you record with the PITCH CONTROL at its maximum or minimum settings, you will have no ability to make further adjustments in that direction upon playback.

### 31 Rewind Button ( ⏮ )

Pressing this button rewinds the tape at high speed. When the tape reaches the beginning or when a MEMORY STOP or ZERO RETURN STOP location is reached, the transport will stop.

### 32 Fast Forward Button ( ⏭ )

Pressing this button winds the tape forward at high speed (fast). When the tape reaches its end or a MEMORY STOP location it will stop.

### 33 STOP Button

The STOP button stops the transport when it is in Play, REcOrd, or Play/PAUSE mode.

### 34 Play Button ( ▶ )

Pressing this button puts the tape transport in the Play mode. When Play mode is on, a green LED over the switch lights.

If the recorder is in REcOrd/PAUSE mode, pressing the Play button will place the transport in REcOrd mode. Pressing the Play button while in REcOrd will stop the recording and switch to the Record Ready mode.

### 35 PAUSE Button

Pressing this button while the recorder is in RECOrd or Play mode, causes the tape to stop. The green LED over the PAUSE button will come on.

The PAUSE button does not turn off the mode that the recorder was in at the time PAUSE was initiated. Whether the recorder was in Play or RECOrd when the PAUSE button was pushed, pressing the Play button will restart either RECOrd or Play. Pressing the RECOrd switch if the recorder is in the RECOrd/PAUSE mode, will not start the RECOrd mode from PAUSE. To start recording, you must press the Play button.

### 36 RECOrd Button

Because it is such an important function, one that can do irreparable damage if used at the wrong time, the RECOrd button, by itself, is pretty ineffectual. It won't do anything unless another switch is pressed in conjunction with it.

Pressing the RECOrd button with the PAUSE button puts the recorder into the RECOrd/PAUSE mode. The recorder will wait for further instructions. The red LED above the RECOrd button will begin to blink and, as mentioned before, the LED above PAUSE will also light. From this mode, you must press the Play

button to begin the recording.

When the Play button is pressed from the RECOrd/PAUSE mode, recording will begin on any tracks that have been selected by their RECORD FUNCTION switches. If no RECORD FUNCTION switches have been pressed, the tape will roll and the LED light above the RECOrd button will continue to blink. This means the recorder is in record ready mode but no recording is taking place. Take a look at the procedure for Punch-in/out for more on this situation.

Switch Setting			LED Condition			Track Status
REC	Play (▶)	RECORD FUNCTION	REC	Play (▶)	RECORD FUNCTION	
Off	Off	Up	—	—	—	Safe (No recording possible)
Off	On		—	On		
On	Off		Blinks	—		
On	On		Blinks	On		
Off	Off	Down	—	—	Blinks	Record ready
Off	On		—	On		
On	Off		Blinks	—		
On	On		On	On		

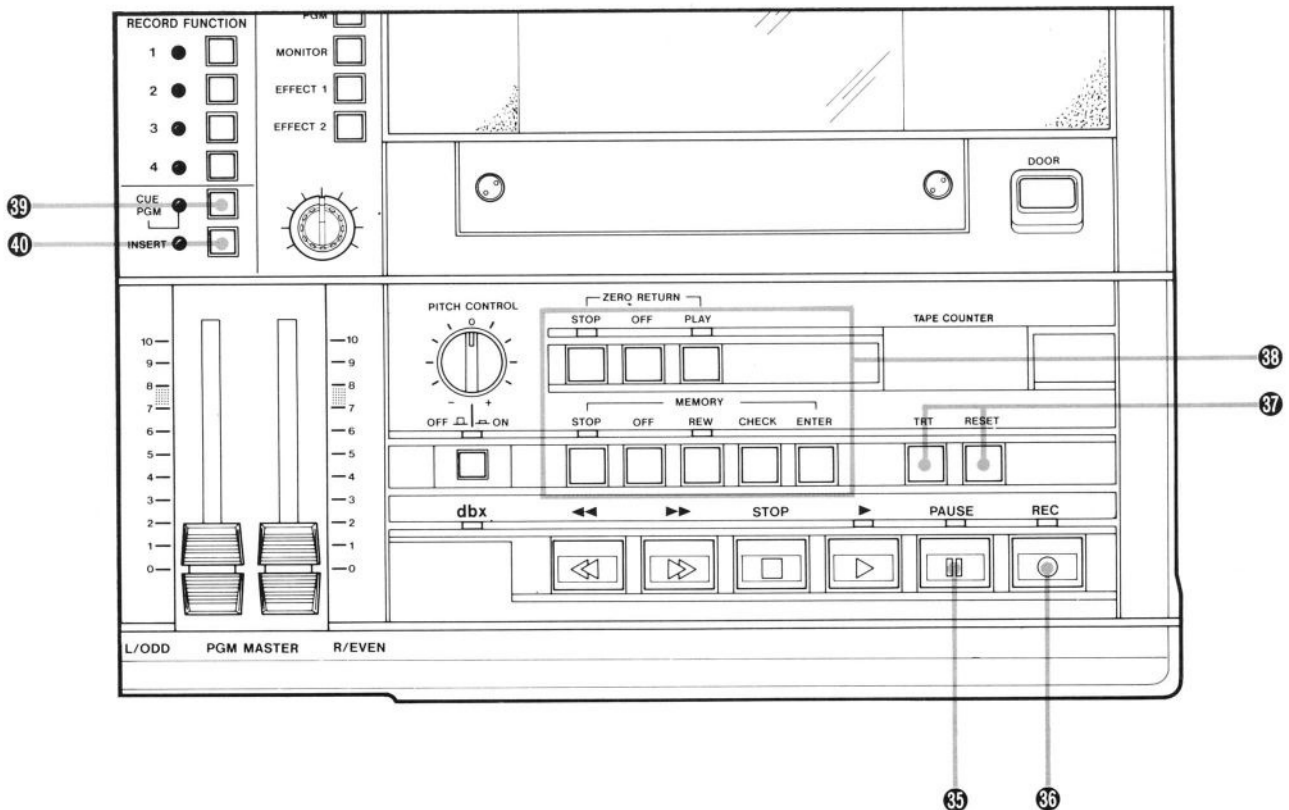



### 37 TRT and RESET Switches

The tape counter has a 4 digit fluorescent readout that indicates tape location. When TRT is in the off (up) position, the display shows an index count that will numerically sequence in both directions (up and down). In the TRT, down position, the display shows the tape run time in minutes and seconds. It will not sequence to a lesser value. TRT is useful for measuring the running time of particular program. The RESET button will clear the display, causing it to show 0000. RESET also cancels any MEMORY position.

### 38 ZERO RETURN and MEMORY Function Switches

When used separately or together, these switches activate a variety of very helpful computer controlled transport functions. The LED indicator lights will show you which functions are in use at any given time.

#### ZERO RETURN Switches

**STOP:** During Rewind, the tape will stop at the zero position when this switch is used.

**PLAY:** This switch functions during Rewind or Fast Forward modes. The tape will enter the PLAY mode when the zero position is reached.

**OFF:** This switch turns off both STOP and PLAY.

#### MEMORY Switches

**ENTER:** This switch marks the current position of the tape and locks it into memory for automatic stop or rewind use.

**CHECK:** Pressing this switch gives you a readout on the display of the memory position or transport mode.

**STOP:** Using this switch will cause the tape to stop when it reaches the memory position no matter what mode (except RECORD) the transport is in ie: Play, Rewind, or Fast Forward.

**REWIND:** If this switch is pressed, the tape will start to rewind when it reaches the memory position. This function won't work in RECORD or if the tape transport is already in Rewind.

**OFF:** This switch turns off the MEMORY functions.

Combining the use of the ZERO RETURN and MEMORY functions.

This combination is most commonly used

to create a "Loop." When ZERO RETURN PLAY and MEMORY REWIND are used together, your Portastudio will repeatedly play back the section of tape between zero and your memory position.

If ZERO RETURN STOP and MEMORY REWIND are used together, the tape will begin rewind when it reaches the memory position and will stop when it rewinds to zero.

ZERO RETURN switches take priority over MEMORY switches. So that if the MEMORY position corresponds to zero, as is the case when the power is first turned on, only the ZERO RETURN switches will have effect if both functions are on.

### 39 CUE/PGM Select Switch

Pressing this switch to the PGM position switches all four channels of the MONITOR mix to the signal present at the MIC/LINE and PGM INPUTs, whether the recorder is in the Play or RECORD mode. This switch takes priority over the INSERT switch. When in the PGM position, you will not be able to monitor the insert function. This is considered normal position for Remix and when using the mixer independently.

With the CUE/PGM switch in the up, CUE position, the INSERT switch becomes effective. This is considered the normal position for the recording basic tracks and overdubbing.

### 40 INSERT Switch

This switch has no effect unless the CUE/PGM select switch is in the CUE position with its LED off.

Pressing this switch allows the Portastudio to automatically switch from tape to source signals during a Punch-in and back to the tape signal at punch-out. Precise Punch-ins are possible because you can listen to both the old material and the new during the actual Punch-in by the means of the automatic switching that takes place.

When a tape is played with the INSERT function on, only the tape signals will be heard, regardless of the RECORD FUNCTION settings. On the other hand, the off position of the INSERT lets you use the RECORD FUNCTION switches to switch between the tape and input signals while playing a tape. This is useful for rehearsing Punch-ins.

**41 RECORD FUNCTION Switches**

Pressing any of these four switches makes the corresponding channel ready to record. If the transport is already in the record ready mode, recording will begin when the RECORD FUNCTION switch is pressed.

A track cannot be recorded unless the RECORD FUNCTION switch designating it is on. A track is therefore "safe" as long as its corresponding switch is off as illustrated in chart on page 32.

**Back Panel**

**42 TAPE OUTPUTS**

These output signals come directly from the recorder section without going through either the REMIX or MONITOR sections of your Portastudio.

**43 dbx Noise Reduction Switches**

These switches turn the dbx on and off. You are given a master on and off for all channels, as well as a separate on and off for track 4. This allows you to use track 4 for data or other signals that the dbx compression and expansion process might damage.

**44 dbx NR Light**

This green LED indicates whether or not the dbx Noise Reduction is on. The LED will blink if Track 4 dbx is off and the other three tracks remain on. dbx should always be used unless you are playing a tape that has not been encoded with dbx.

**45 REMOTE PUNCH IN/OUT Connector**

This phone jack is for the connection of the optional TASCAM RC-30P Remote Pedal.

**46 REMOTE CONTROL Connector**

This twelve pin connector accepts the cable from the optional RC-71 Remote Control Unit.

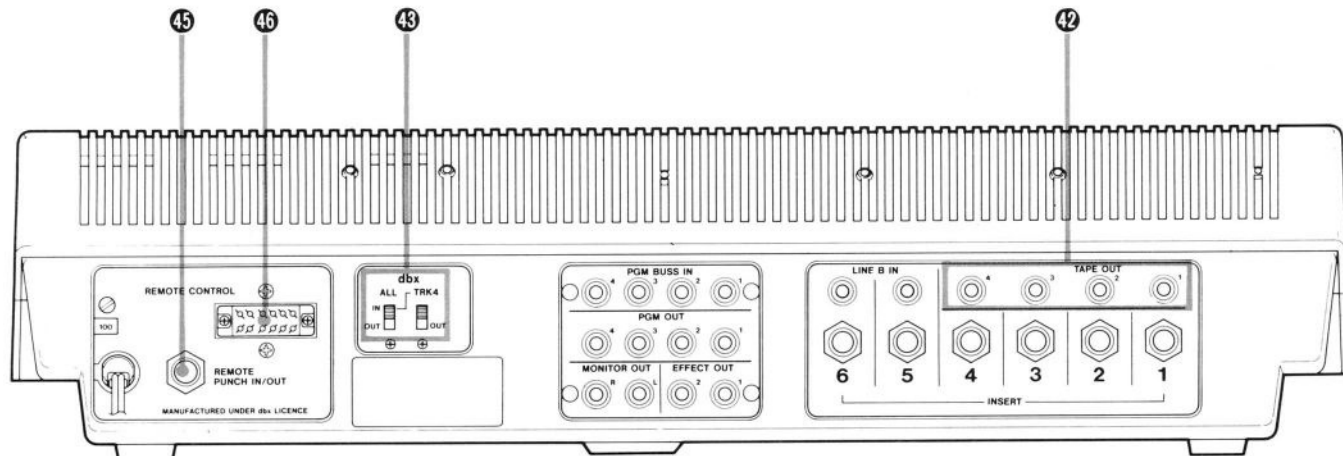
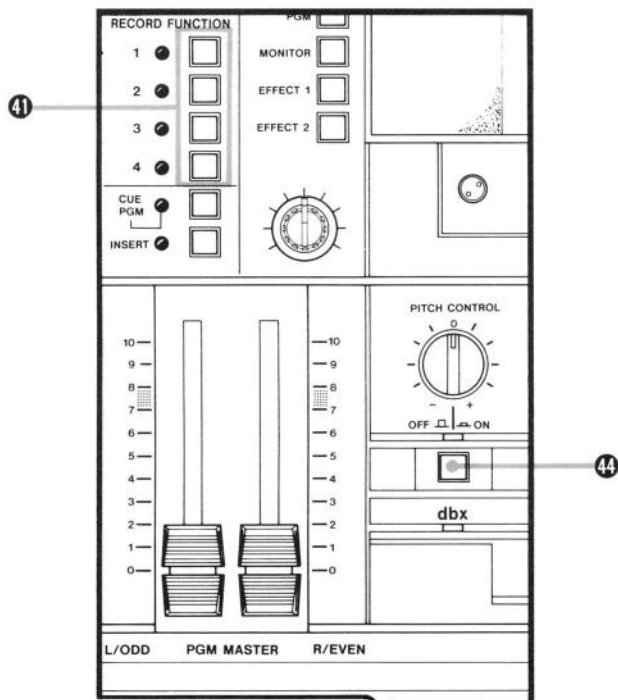

# Accessories

## E-3 Demagnetizer



The E-3 is essential for eliminating the residual magnetism that builds up on the heads, as well as other metal parts along the tape path. Demagnetization is part of regular recorder maintenance, and the TEAC E-3 is the right tool for the job.

## E-2A Bulk Eraser



The E-2A allows you to erase cassettes, as well as 7" and 10" reels of tape, quickly and completely. It comes with a pilot light and integral circuit breaker to protect against overheating.

## RC-30P Remote Pedal



The RC-30P is a durable footswitch that connects to the REMOTE PUNCH IN/OUT jack on the rear panel of the Portastudio. This permits "hands free" entry and exit from the record mode.

## RC-71 Remote Control Unit

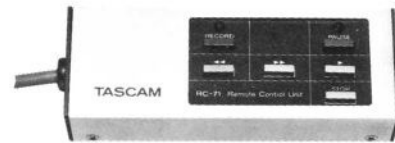

This unit makes remote control of the transport functions possible. It plugs into a multipin connector on the rear of the Portastudio.

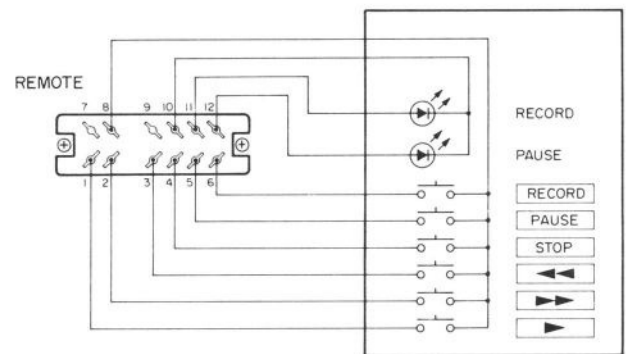

## 109B Input Transformer



The TASCAM 109B Input Transformer is an adaptor that matches balanced low impedance microphones with XLR connectors to unbalanced high impedance 1/4" phone jack inputs. This adaptor enables a long cable from the low impedance mic to remain balanced for rejection of hum and buzz. The male XLR connector on the end of the cable farthest from the mic is then connected to the 109B, and the 109B's phone plug is connected to the 1/4" phone jack. This approach is far superior to simply wiring a phone plug onto a 3-wire cable from the mic. The 109B not only maintains the noise rejection of the balanced low impedance mic, it also properly loads the mic to preserve correct frequency response. If you have an unbalanced input and a professional mic, the 109B is the ideal transformer.

## PW-2Y/PW-4Y Insertion Cable



The TASCAM PW-2Y/PW-4Y is a connecting cable that allows signal processing such as a graphic equalizer to be inserted at specific points of the signal path of the Portastudio. Its tip-ring-sleeve plug connects to the INSERT jack while its "Y'ed" end accommodates connection to the input and output terminals of the outboard equipment being used. Available in two lengths — 2 m (PW-2Y) and 4 m (PW-4Y).

### TASCAM Cables

Cable, because of its inherent capacitance and resistance, is an active component in an audio system. There are vast differences in cable design and performance that have significant effect on the sound quality you'll get from your equipment. TASCAM Professional Audio Cables are the best available.

Our cables feature very low capacitance (under 15 picofarads/foot) so they don't act as low-pass filters and roll off high frequencies. The capacitance is also consistent; it doesn't change when the cable is bent or compressed. You don't get noise or degraded results when the cable has been used a while. Our cable's long-term stability is provided by a special insulator that is as flexible as foam core dielectrics, but far more resistant to extreme cold or heat, and it doesn't let the center strands migrate. It also avoids the possibility of shearing the center conductor when the cable is crushed, so that cable does not suddenly fail.

Rather than loosely braided shield or spiral wrapped shield that can open up, we use bare copper braided shield with 97 % coverage. This excludes electrostatic noise (buzz) and RFI (CB interference, etc.). We also use a 7-strand center

conductor: 4 pure copper strands for minimum resistance and 3 copper weld stainless steel strands for strength. The multiple strands increase flexibility and strength while offering less resistance at ultra high frequencies due to increased surface area for the "skin effect." This improves transient response.

The outer PVC insulating jacket resists abrasion, and is tightly fitted to the shield so it will not elongate. The connectors are special, too. Their nickel-plated brass center pins are a bit longer than most to establish good contact in all RCA jacks. The cadmium-plated steel outer shell includes a gentle ridge which burnishes the mating jack when the connector is twisted to ensure good contact. For maximum RF shielding, the braid is terminated inside the shell and 2-radian soldered, not just spot soldered, for maximum strength. The plugs are clad with an oval jacket of molded plastic to further increase strength and make the ends easier to handle. TASCAM cable is available in lengths from 6 inches to 20 feet, or in color-coded sets of 8 for fast channel or function identification. TASCAM cable is also available in 500 foot spools.

If TASCAM professional cables are not available in your area, please try to find the next best cables. It really does make a difference in system performance.

## TZ-261 Cleaning Kit (Except U.S.)



like alcohol can cause drying and cracking of pinch rollers. TEAC RC rubber cleaner contains no alcohol. Its special solvents wipe off tape oxide, and other chemicals in RC actually rejuvenate the rubber. This increases its resiliency and enhances its ability to pull tape without slippage. HC and RC can be purchased with swabs in a tape recorder cleaning kit (part #TRC.).

## PB-64 Patch Bay

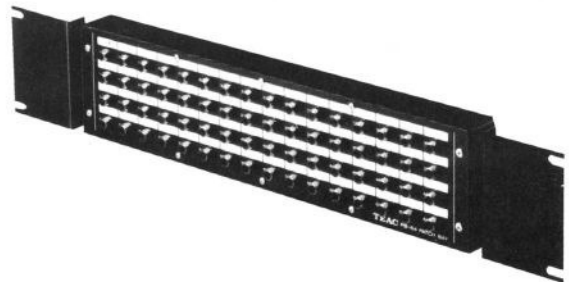

When your system begins to expand beyond the basic, sorting out where things go can take much time away from the recording process. This accessory will allow you to speed things up and get back to what you really want to do. Sixty-four RCA pins on a panel. So you can bring all those jacks to where you are. It will get you off the floor and back to recording. Connect all your inputs and outputs to the back, and you can reroute your signals with short jumpers quickly.



Using the right chemicals is important because strong solvents can dissolve the binder that holds the head laminations together. Isopropyl alcohol can leave a residue and is not always adequate for cleaning desposits from modern tape formulations. Beware of rubbing alcohol; while it is isopropyl, it also contains oil and water that leave a heavy film on the heads. TEAC HC head cleaner is formulated to clean tape heads, tape guides, and capstans without leaving a film or damaging head integrity.

Since pinch rollers are made of special rubber compound, not metal, a different solvent is needed for cleaning them. Even a mild solvent

## PB-32 Series Patch Bays

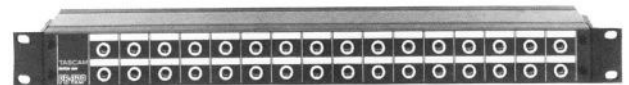

The PB-32 patch bay is today's simplest and most effective way to deal with the ever-increasing tangle of wires necessary for the recording and signal processing you want to do. Instead of leaning over, walking around, or turning consoles, racks, recorders and other equipment, you can bring all those confusing cable ends to one single spot in your rack, or next to your mixer, and get them under control. You can label inputs and outputs on the PB-32, and wan't have to guess anymore at what you might be plugging in. A few cords can save endless hours of searching around on the floor

behind your console and, as the whole process of patching is made simpler, you'll probably find more flexibility in your recording setup. The PB-32 comes in four versions. The PB-32P is equipped with 1/4" phone jacks only, the PB-32R with RCA jacks only, the PB-32H with 1/4" phone jacks on one side and RCA jacks on the other, and the PB-32W with 1/4" phone jacks for 6 channels and RCA jacks for the remaining 10 channels.

### M-1B Line Mixer

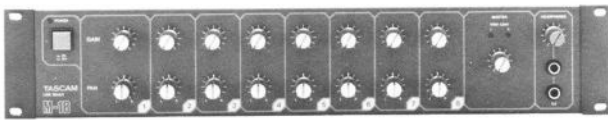

The M-1B is an 8-in, 2-out line mixer that provides you with an easy and practical way of creating an independent mix such as cue or monitor mixes. Rack mountable (19" EIA).

### MX-80 Mixer



This is an 8-in, 2-out mic/line mixer useful as a fully functional, ingenious submixer for obtaining an extra mic or line mix. Versatility of your system will be considerably enhanced. Rack mountable (19" EIA).

### MH-40B Headphone Amp



The MH-40B is a headphone distribution amplifier that can be used to feed four sets of studio cue headphones and can be mounted in a 19" EIA rack.

### PE-40 Parametric EQ



The PE-40 is a 4-channel, 4-band parametric equalizer providing precise control over the frequency characteristics of any line level program. Rack mountable (19" EIA).

### GE-20B Graphic EQ



The GE-20B is a 2-channel, 10-band graphic equalizer offering an easy means of controlling the tonal balance between channels. Rack mountable (19" EIA).

## Voltage Conversion

This unit is adjusted to operate on the electric voltage specified on the unit, power cord tag, or packing carton.

**NOTE:** This voltage conversion is not possible on models sold in the U.S.A., Canada, UK, Australia or Europe.

For general export units, if it is necessary to change the voltage requirements of the Portastudio to match your area, use the following procedures. **ALWAYS DISCONNECT THE POWER LINE CORD BEFORE MAKING THESE CHANGES.**

1. Locate the voltage selector on the rear of the Portastudio.
2. Using a regular (slot blade) screwdriver, turn the selector until the numerals corresponding the voltage requirements of your area appear.

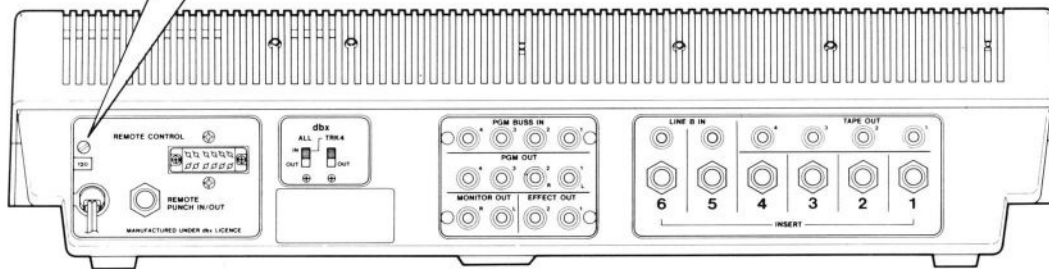
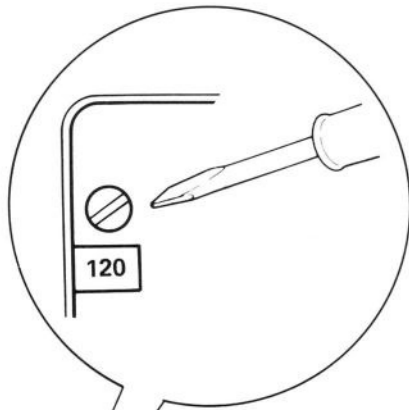

## Note for U.K. Customers

### U.K. CUSTOMERS ONLY:

Due to the variety of plugs being used in the U.K., this unit is sold without an AC plug. Please request your dealer to install the correct plug to match the mains power outlet where your unit will be used as per these instructions.

### IMPORTANT

The wires in this mains lead are coloured in accordance with the following code:

**BLUE:        NEUTRAL**  
**BROWN:      LIVE**

As the colours of the wires in the mains lead of this apparatus may not correspond with the coloured marking identifying the terminals in your plug, proceed as follows.

The wire which is coloured BLUE must be connected to the terminal which is marked with the letter N or coloured BLACK. The wire which is coloured BROWN must be connected to the terminal which is marked with the letter L or coloured RED.

This product is manufactured to comply with the radio interference of EEC directive "82/499/EEC."

# Pictogram

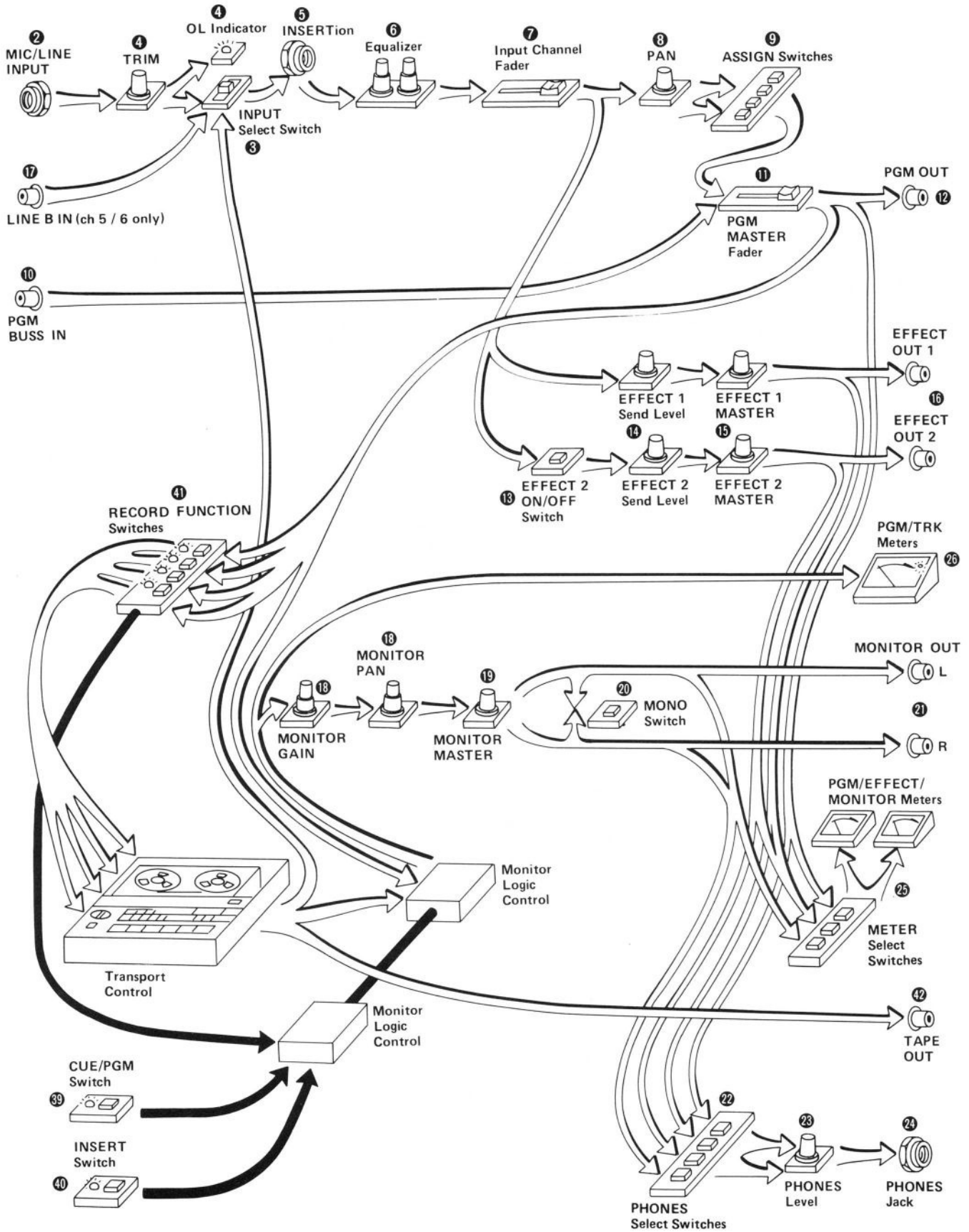



# Block Diagram

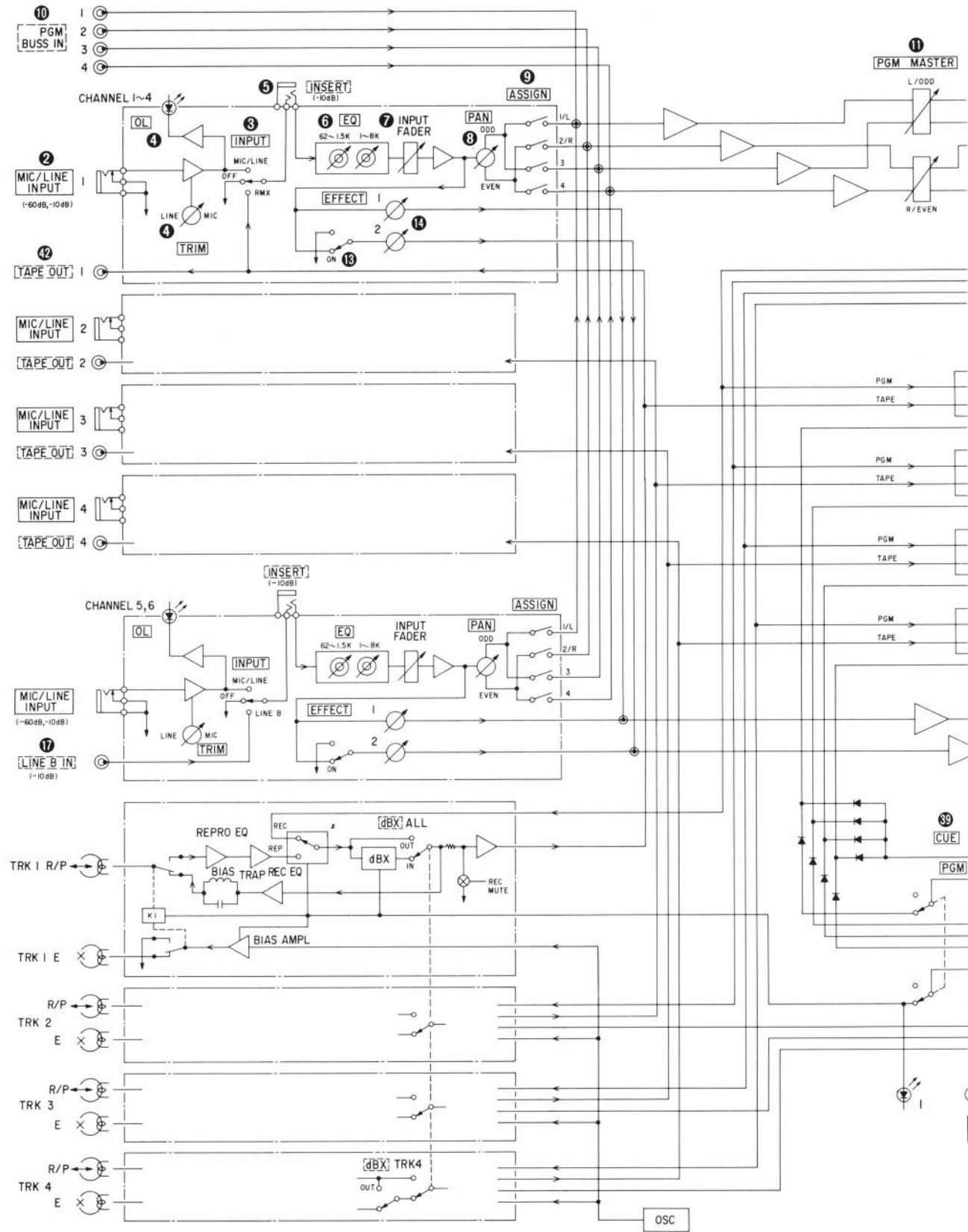

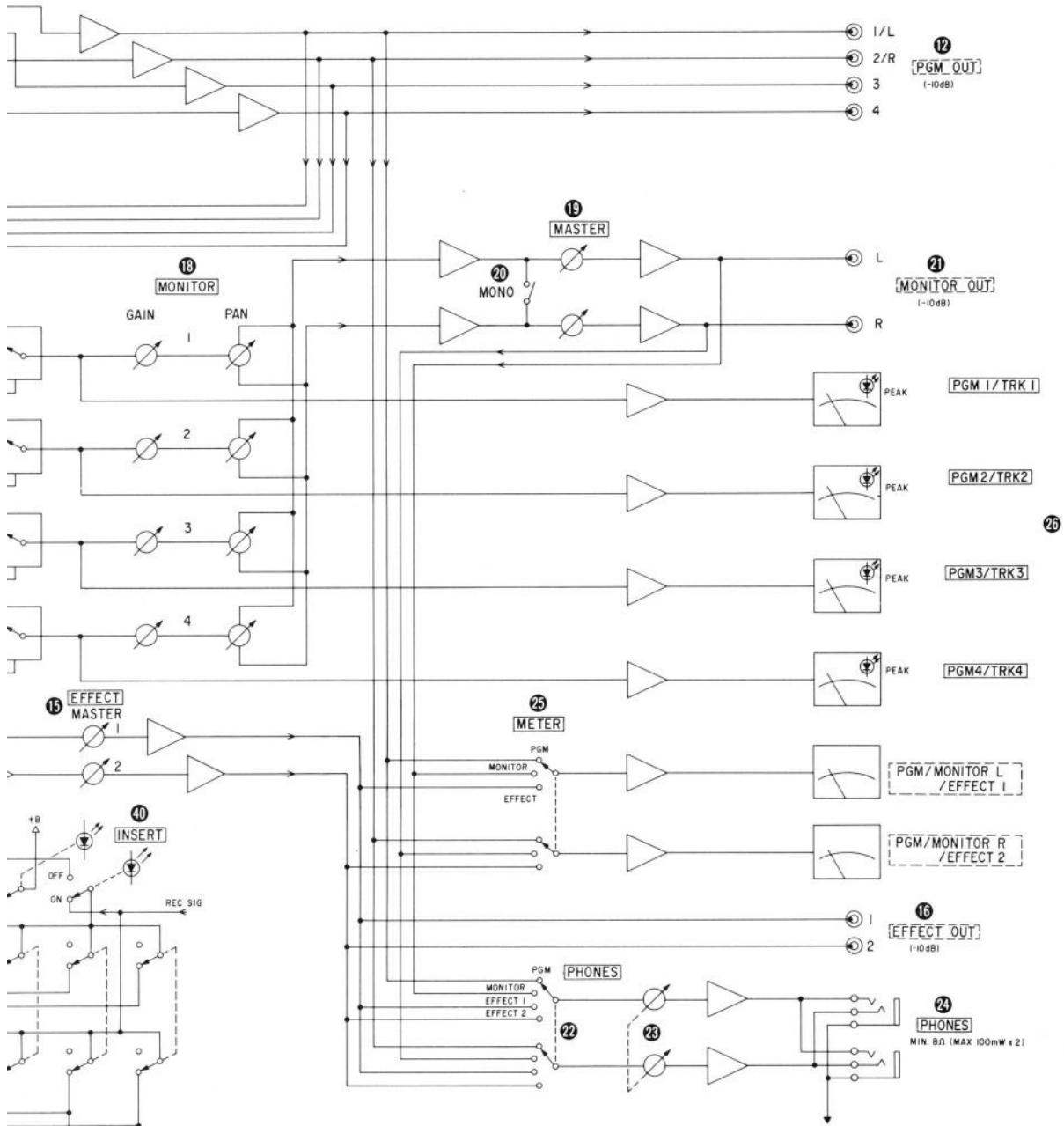

SYMBOLS

	RCA JACK		PUSH SWITCH		PAN POT		CONNECTION NODE
	1/4" JACK (INSERT BREAK)		LEVER SWITCH		LED		SUMMING NODE
	1/4" STEREO JACK		ROTARY POT		VU METER (WITH PEAK LED)		GROUND
	OP. AMPL.		LINER FADER				

# Level Diagrams

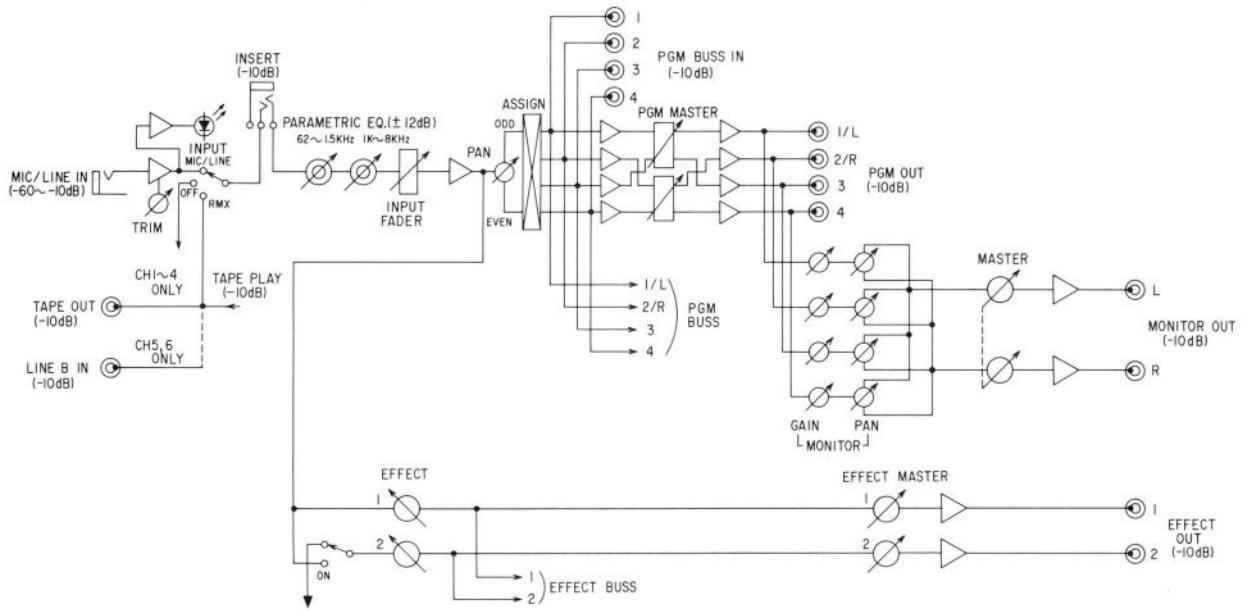

## ① INPUT / BUSS / MONITOR SECTION

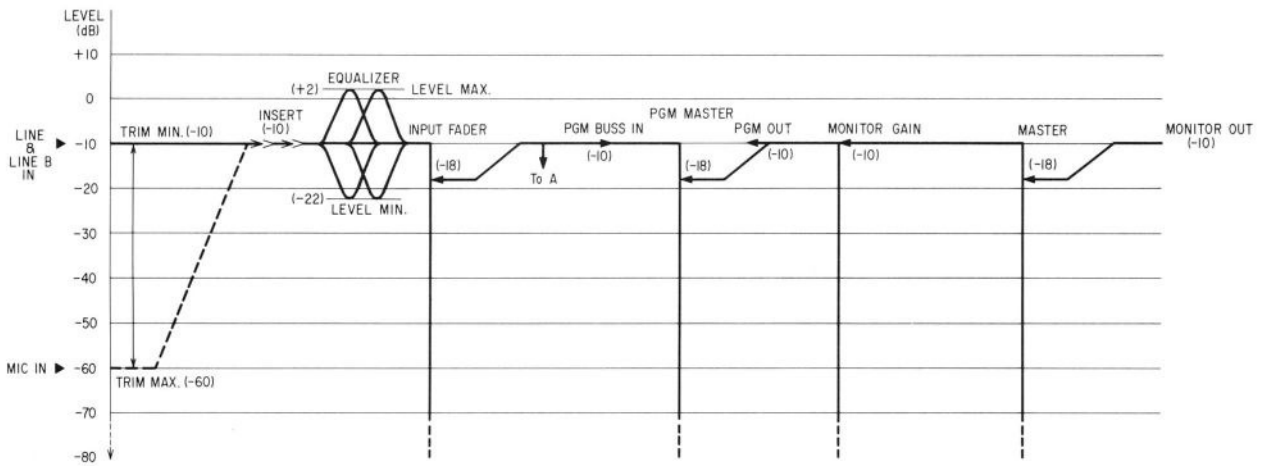

## ② EFFECT SECTION

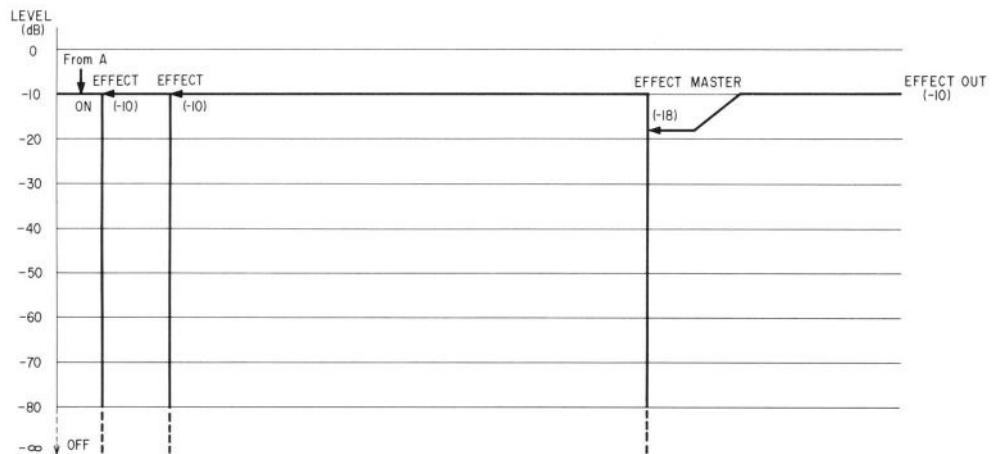

(AT 315Hz)

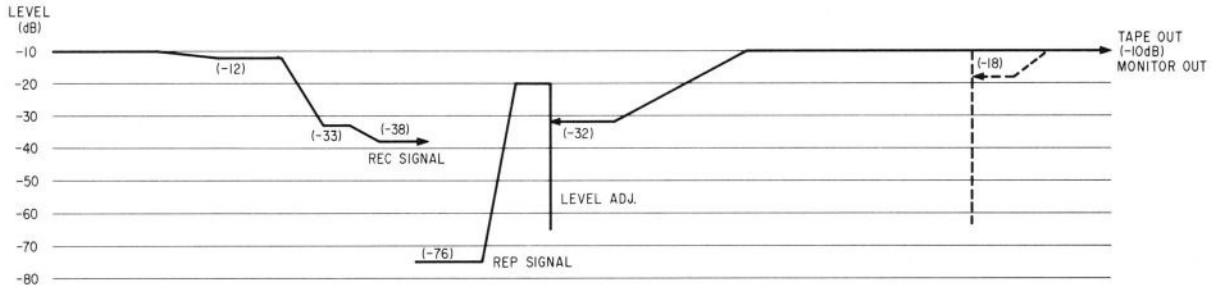
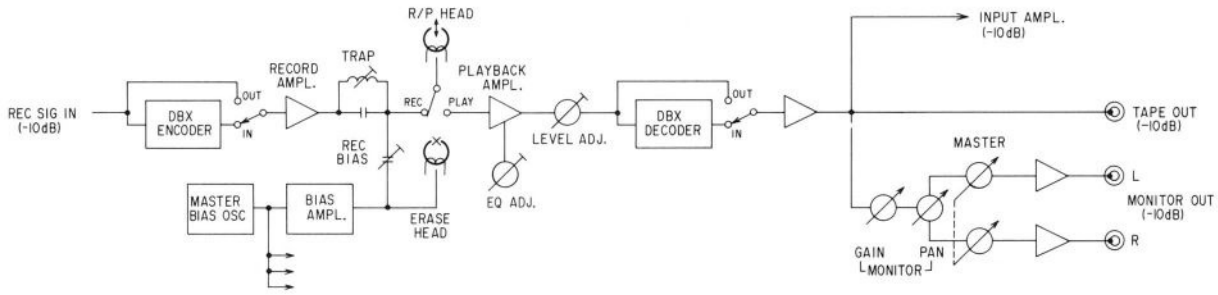

## Specifications

### MECHANICAL CHARACTERISTICS

Tape	Compact cassette, 70 $\mu$ s, Hi-bias (Type II) tape
Track Format	4-track, 4-channel
Head Configuration	1 Erase, 1 Record/ Reproduce
Motors	1 FG Servo-controlled DC Capstan; 1 DC Reel; 1 DC ancillary
Tape Speeds <sup>3</sup>	3-3/4 ips (9.5 cm/s) and 1-7/8 ips (4.8 cm/s)

Speed Accuracy	$\pm 1.0$ % deviation
Pitch Control	$\pm 12$ %
Fast Wind Time	Approx. 85 seconds for C-60
Pause Start Time	Less than 0.5 sec. to reach standard Wow and Flutter
Dimensions (W x H x D)	500 x 401 x 123 mm (19-11/16" x 15-13/16" x 4-13/16")
Weight (net)	10.3 kg (22.7 lbs)

## ELECTRICAL CHARACTERISTICS

### MIXER SECTION

#### MIC/LINE Input

Input Impedance	100k ohms, unbalanced
Source Impedance	Less than 10k ohms
Nominal Input Level	-60 dBV (1 mV), MIC (Trim max.) -10 dBV (0.3 V), LINE (Trim min.) +15 dBV (5.6 V)
Maximum Input Level	+15 dBV (5.6 V)

#### LINE B Input

Input Impedance	28k ohms
Nominal Input Level	-10 dBV (0.3 V)
Maximum Input Level	+15 dBV (5.6 V)

#### PGM Buss Input

Input Impedance	22k ohms
Nominal Input Level	-10 dBV (0.3 V)
Maximum Input Level	+15 dBV (5.6 V)

### INSERTION

#### SEND (Tip)

Output Impedance	100 ohms
Nominal Load Impedance	10k ohms
Minimum Load Impedance	1.7k ohms
Nominal Output Level	-10 dBV (0.3 V)
Maximum Output Level	+15 dBV (5.6 V)

#### RECEIVE (Ring)

Input Impedance	68k ohms
Nominal Input Level	-10 dBV (0.3 V)
Maximum Input Level	+15 dBV (5.6 V)

### PGM/EFFECT/MONITOR Output

Output Impedance	100 ohms
Nominal Load Impedance	10k ohms
Minimum Load Impedance	1.7 kohms
Nominal Output Level	-10 dBV (0.3 V)
Maximum Output Level	+15 dBV (5.6 V)

### HEADPHONES Output

Nominal Load Impedance	8 ohms, stereophones
Maximum Output Level	100 mW/ch. (8 ohms)

### Equalizer

Type	2-band, peak/dip, sweepable
Frequencies	Low/Mid; 62 Hz to 1.5 kHz Mid/High; 1 kHz to 8 kHz

Boost/Cut Range ±12 dB

### Input Overload Indicator

Activates at 24 dB above nominal

### PGM Buss Peak Indicator

Activates at 8 dB above nominal

### RECORDER SECTION

#### Tape Out

Output Impedance	100 ohms
Nominal Load Impedance	10k ohms
Minimum Load Impedance	1.7k ohms
Nominal Output Level	-10 dBV (0.3 V)
Maximum Output Level	+15 dBV (5.6 V)

#### Bias Frequency

Equalization	85 kHz High Speed; 3,180 $\mu$ s + 35 $\mu$ s Low Speed; 3,180 $\mu$ s + 70 $\mu$ s
--------------	---

#### Record Level Calibration

160 nWb/m (0 VU reference)

#### Noise Reduction

4 Channel, dbx II, dual process

### Power Requirements

USA/CANADA	120 V AC, 60 Hz
EUROPE	220 V AC, 50 Hz
UK/AUSTRALIA	240 V AC, 50 Hz
GENERAL EXPORT	100/120/220/240 V AC, 50/60 Hz
Power Consumption	40 W

## TYPICAL PERFORMANCE CHARACTERISTICS

### MIXER SECTION

Frequency Response	20 Hz – 20 kHz $\pm$ 1 dB
Signal-to-Noise Ratio	IHF A WTD/UNWTD (20 – 20 kHz)
1 Mic to PGM Out	68 dB/65 dB
1 Line to PGM Out	85 dB/80 dB
Total Harmonic Distortion <sup>2)</sup>	0.05 %, nominal level
Crosstalk <sup>2)</sup>	65 dB

### RECORDER SECTION

Wow and Flutter <sup>3)</sup> HIGH speed	0.04 % (NAB weighted) $\pm$ 0.06 % peak (DIN/IEC/ ANSI weighted)
LOW speed	0.05 % (NAB weighted) $\pm$ 0.1 % peak (DIN/IEC/ ANSI weighted)
Frequency Response <sup>4)</sup> (Record/Reproduce)	
HIGH speed	20 Hz – 18 kHz 40 Hz – 14 kHz, $\pm$ 3 dB
LOW speed	40 Hz – 14 kHz 40 Hz – 12.5 kHz, $\pm$ 3 dB
Signal-to-Noise Ratio <sup>4)</sup> (Reference to 3 % THD)	IHF A WTD/UNWTD (20 – 20 kHz)
HIGH speed	95 dB/90 dB with dbx* 58 dB/55 dB without dbx
LOW speed	93 dB/88 dB with dbx 57 dB/54 dB without dbx
Total Harmonic Distortion <sup>1, 4)</sup>	
HIGH speed	1.0 %, 0 VU, with/without dbx
LOW speed	1.0 %, 0 VU, with/without dbx
Adjacent Channel Separation <sup>2)</sup> (0 VU)	70 dB with dbx 55 dB without dbx
Erasur (referenced to 3 % THD level)	70 dB at 1 kHz

Specifications were determined using (1) 315 Hz and (2) 1 kHz as reference.

Specifications were determined using TEAC test tape; (3) MXT-111; (4) MTT-5061.

In these specifications, 0 dBV is referenced to 1.0 Volt rms. Actual voltage levels are also given in parenthesis. To calculate the 0 dB = 0.775 Volt reference level (i.e., 0 dBu or 0 dBm in a 600 ohm circuit) add 2.2 dB to the listed dBV value, i.e., 0 dBV = +1.0 volt = +2.2 dBu. Changes in specifications and features may be made without notice or obligation.

\*dbx is a registered trademark of dbx Incorporated.

# TASCAM

TEAC Professional Division

# 246

---

**TEAC CORPORATION**

MAIN OFFICE: 3-7-3 NAKACHO MUSASHINO TOKYO PHONE (0422) 53-1111  
SALES OFFICE: 4-15-30 SHIMORENJAKU MITAKA TOKYO PHONE (0422) 45-7741

---

TEAC CORPORATION OF AMERICA

7733 TELEGRAPH ROAD MONTEBELLO CALIFORNIA 90640 PHONE (213) 726-0303

---

TEAC CANADA LTD.

3610 NASHUA DRIVE UNIT 1 & 2 MISSISSAUGA ONTARIO L4V 1L2 PHONE 416-673-3303

---

TEAC AUSTRALIA PTY., LTD.

115 WHITEMAN STREET SOUTH MELBOURNE VICTORIA 3205 PHONE 699-6000

---

PRINTED IN JAPAN 1086U2-D-4849I